

# USH-9

Ultrasonic level sensor

## Manual

Setup version 2.45 (Firmware 1.83)

12.07.2021



Sommer Messtechnik

All rights reserved.

The Copyrights for this manual are exclusively owned by

Sommer Messtechnik  
6842 Koblach  
Austria

This manual or parts of it may only be copied or passed on to third parties with written permission of Sommer Messtechnik. This applies to printed as well as digital issues of this manual.



Sommer Messtechnik  
Strassenhäuser 27  
6842 Koblach  
Austria  
[www.sommer.at](http://www.sommer.at)  
E [office@sommer.at](mailto:office@sommer.at)  
T +43 5523 55989  
F +43 5523 55989-19

## Validity

This manual applies to the Ultrasonic level sensor with the setup version 2.45, including all its sub-versions.

Created: 19.10.2018

Last update: 12.07.2021

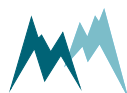

# EU conformity



This product is in conformity with the following standards:

EMC	2014/30/EU	EN 61326-1: 2013
LVD	2014/35/EU	EN 62311:2008
		EN 62368-1:2014
RoHS II	2011/65/EU	
RoHS III	2015/863/EU	

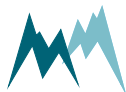

# Safety information

Please read this manual carefully before installing or operating this equipment. Non-compliance with the instructions given in this manual can result in failure or damage of the equipment or may put people at risk by injuries through electrical or mechanic impact.

- Installation and electrical connections must be carried out by qualified personnel familiar with the applicable regulations and standards.
- Do not perform any installations in bad weather conditions, e.g. thunderstorms.
- Prior to installation of equipment inform the owner of the measurement site or the authority responsible for it. Upon completion, secure the installation from trespassers.
- Maintenance and repair must be performed by trained personnel or an engineer of Sommer Messtechnik. Only replacement parts supplied by Sommer Messtechnik should be used for repairs.
- Make sure that NO power is connected to the equipment during installation and wiring.
- Only use a power supply that complies with the power rating specified for this equipment.
- Keep equipment dry during wiring and maintenance.
- If applicable, it is recommended to use accessories of Sommer Messtechnik with this equipment.

## Disposal



After this device has reached the end of its lifetime, it must not be disposed of with household waste! Instead, dispose of the device by returning it to a designated collection point for the recycling of waste electrical and electronic equipment.



## Feedback

Should you come across any error in this manual, or if you miss information to handle and operate the USH-9 we are pleased to receive your feedback to [office@sommer.at](mailto:office@sommer.at).



# Content

- 1 What is the USH-9? ..... 11
- 2 Unpacking ..... 12
- 3 Get started ..... 13
  - 3.1 Connect the USH-9 to your PC ..... 13
  - 3.2 Configure the USH-9 ..... 14
  - 3.3 Acquire measurements ..... 14
- 4 How the USH-9 works ..... 15
- 5 Components ..... 16
  - 5.1 MAIN connector ..... 16
- 6 Specifications ..... 17
- 7 Installation ..... 19
  - 7.1 Site selection ..... 19
  - 7.2 Things to consider for installation ..... 19
    - 7.2.1 Power supply ..... 20
    - 7.2.2 Signal cables ..... 21
    - 7.2.3 Lightning protection ..... 21
  - 7.3 Required tools and equipment ..... 21
  - 7.4 Mounting ..... 22
  - 7.5 Wiring ..... 22
    - 7.5.1 RS-485 ..... 22
    - 7.5.2 SDI-12 ..... 23
    - 7.5.3 How to wire analog outputs ..... 24
  - 7.6 Testing ..... 24
  - 7.7 Adjustment ..... 24
  - 7.8 Start-up ..... 25
- 8 Operation ..... 26
  - 8.1 Connect device to PC ..... 26
  - 8.2 How do I test the USH-9 indoors? ..... 26
- 9 Maintenance ..... 28
- 10 Support software Commander ..... 29
  - 10.1 Software features ..... 29
  - 10.2 System requirements ..... 29
  - 10.3 Installation of Commander ..... 29
  - 10.4 Working with connections ..... 34
    - 10.4.1 Establish a connection with the Communication assistant ..... 34
    - 10.4.2 Establish a connection manually ..... 35
    - 10.4.3 Create a new connection ..... 35

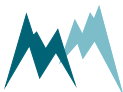

10.5	Working with stations	35
10.5.1	Create a station with the Communication assistant	35
10.5.2	Create a station manually	40
10.6	Working with measurements	40
10.6.1	Poll continuous measurements	40
10.6.2	Record measurements	41
10.7	Working with data	42
10.7.1	View live data	42
10.8	Working with spectra	42
10.8.1	Record spectrum	42
10.8.2	Read spectrum file	43
10.9	Working with parameter (setup) files	43
10.9.1	Download setup	43
10.9.2	Open a setup file	43
10.9.3	Edit setup	44
10.9.4	Upload new setup file	44
10.10	Update firmware	44
11	Configuration of the USH-9	47
11.1	Software tools	47
11.2	Configuration with Commander support software	47
11.3	Configuration with a terminal program	50
11.4	Conflict messages	51
11.4.1	Parameter conflict	52
11.4.2	Setup conflict	52
11.5	General settings	53
11.5.1	Measurement trigger	53
11.5.2	Language/Sprache	54
11.5.3	Decimal character	54
11.5.4	Units and decimals	54
11.5.5	Output protocol (OP)	54
11.5.6	OP, information	54
11.6	Level/Distance measurements	55
11.6.1	Measurement duration	55
11.6.2	Level/distance test	55
11.6.3	Adjust level	55
11.6.4	Distance to zero level	55
11.6.5	Application	55
11.6.6	Moving filter, duration	56
11.6.7	Moving filter, type	56

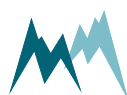

11.7	Configuring the USH-9 for snow measurements .....	57
11.8	Configuring the USH-9 for water level measurements .....	57
12	Communication .....	59
12.1	Communication protocols .....	59
12.2	Data output .....	59
12.2.1	Main values .....	59
12.2.2	Special values .....	60
12.2.3	Analysis values .....	60
12.2.4	Exception values .....	61
12.3	RS-485 .....	62
12.3.1	What is RS-485? .....	62
12.3.2	What can I do with it? .....	62
12.3.3	Configuration .....	62
12.3.4	Data output options .....	64
12.3.5	Sommer protocol .....	64
12.3.6	Standard protocol .....	68
12.3.7	Sommer old protocol .....	70
12.3.8	RS-485 commands .....	71
12.3.9	Sommer CRC-16 .....	73
12.4	SDI-12 .....	74
12.4.1	What is SDI-12? .....	74
12.4.2	What can I do with it? .....	74
12.4.3	Configuration .....	74
12.4.4	Data structure .....	74
12.4.5	SDI-12 commands .....	75
12.5	Modbus .....	79
12.5.1	What is Modbus? .....	79
12.5.2	What can I do with it? .....	80
12.5.3	Wiring .....	80
12.5.4	Configuration .....	80
12.5.5	Modbus commands and registers .....	86
12.5.6	Reactivate Sommer protocol .....	89
12.5.7	PLC integration .....	94
13	Analog output .....	95
13.1	What can I do with it? .....	95
13.2	How to wire analog outputs .....	95
13.3	Activation .....	95
13.4	Scaling .....	96
13.4.1	IOUT 1 .....	96
13.4.2	IOUT 2 .....	97

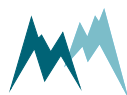

13.5	Simulate current output	98
14	Parameter definitions	99
A	Measurement trigger	99
B	Measurement Interval	99
C	Level and distance	100
C-A	Measurement duration	100
C-B	Level/distance test	100
C-C	Adjust level	100
C-D	Distance to zero level	101
C-E	Application	101
C-F	Moving filter, duration	101
C-G	Moving filter, type	102
D	Technics	103
D-A	Language/Sprache	103
D-B	Decimal character	103
D-C	SDI-12 address	103
D-D	Units and decimals	104
D-D-A	Level, unit	104
D-D-B	Level, decimals	104
D-D-C	Temperature, unit	105
D-D-D	Temperature, decimals	105
D-E	Temperature	105
D-E-A	Offset	105
D-E-B	Adjustment	105
D-E-C	Test	106
D-F	IOUT settings	106
D-F-A	Status	106
D-F-B	IOUT1, function	106
D-F-C	IOUT1, 4-20 mA span	107
D-F-D	IOUT1, 4 mA value	107
D-F-E	IOUT2, function	107
D-F-F	IOUT2, temperature 4-20 mA span	108
D-F-G	IOUT2, temperature 4 mA value	108
D-F-H	IOUT2, status hold time	108
D-F-I	Simulate current output	109
D-G	Status limits	109
D-G-A	Level limit	109
D-G-B	Snow settling, strength drop	110
D-G-C	Snow settling, maximum level	110
D-G-D	Snowfall, precipitation limit	110
D-G-E	Snowfall, max. temperature	110
D-H	Advanced settings	111





	D-H-A	Optimisation	111
	D-H-B	Max. measurement distance	111
	D-H-C	View spectral distribution	112
	D-H-D	Maximum standard deviation	112
	D-H-E	Rate of change, maximum (./h)	112
	D-H-F	RoC, max. without precip. (./h)	112
	D-H-G	RoC, max. at precip. (./h)	113
	D-H-H	Precipitation, filter duration	113
	D-H-I	Reset behavior	113
	D-H-J	Sleep mode	114
	D-H-K	Sommer ID	114
D-I		RS-485 Protocol	114
	D-I-A	Device number	115
	D-I-B	System key	115
	D-I-C	Output protocol (OP)	115
	D-I-D	OP, measurement output	116
	D-I-E	OP, information	116
	D-I-F	OP, wake-up sequence	116
	D-I-G	OP, prefix holdback	117
	D-I-H	MODBUS, set default	117
	D-I-I	MODBUS, device address	117
D-J		RS-485 Port	117
	D-J-A	Baud rate	118
	D-J-B	Parity, stop bits	118
	D-J-C	Minimum response time	119
	D-J-D	Transmitter warm-up time	119
	D-J-E	Flow control	119
	D-J-F	Sending window	119
	D-J-G	Receiving window	120
E		Special functions	120
	E-A	Device status	120
	E-B	View setup	120
	E-C	Continuous meas. mode (temp).	120
	E-D	Set factory default	121
	E-E	Temp. load factory default	121
	E-F	Relaunch program	121
F		Measurement table	121
Appendix A Device Errors			122
Appendix B Troubleshooting			124
B.1		Devices	124
	B.1.1	The USH-9 is not responding	124
	B.1.2	The USH-9 reboots repeatedly	126

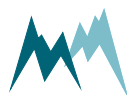

B.2	Measurement data .....	126
B.2.1	Measurement data are not updated .....	126
B.2.2	Snow height increase is retarded .....	126
B.2.3	Recorded data show frequent data gaps .....	127
B.3	Firmware & software .....	127
B.3.1	Commander loads wrong setup .....	127
B.3.2	Firmware update via RS-485 is aborted .....	127
B.4	SDI-12 .....	128
B.4.1	Data logger receives no SDI-12 data .....	128
B.4.2	The USH-9 is not detected by a SDI-12 master device .....	128
B.5	Analog output .....	129
B.5.1	The 4-20 mA output is wrong .....	129
Appendix C	CRC-16 array .....	130

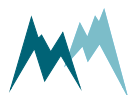

# 1 What is the USH-9?

Continuous snow depth and water-level measurements are very important in avalanche risk forecast and water resource management .

The USH-9 is a continuous measurement device for the contact-free determination of snow depth and water level. It measures the transit time of an ultrasonic signal between a variable surface and the USH-9 sensor, and translates it to a snow or water level. An integrated processor compensates the detected signal for temperature and filters interfering reflections of precipitation within the measurement path.

The USH-9 sensor contains an additional feature to sense precipitation and to discriminate snow from rain. This offers the option to detect the settling of snow, used for example in road weather monitoring systems.

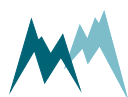

## 2 Unpacking

When unpacking your USH-9 sensor box please make sure that the following items are present:

Qty	Name
1	USH-9 sensor including sensor mount, sensor cable 10 m and RS-485 to USB converter
1	Manual and Commander Software on USB stick
1	Commander support software

In case of missing or damaged items please contact your Sommer Messtechnik sales partner.

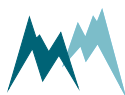

## 3 Get started

Follow the steps described below to set the basic configurations and to acquire the first measurement results.



**NOTE** Perform the first start-up in your lab or office before installing the equipment in the field!

### 3.1 Connect the USH-9 to your PC

1. Install the Commander support software (see [Installation of Commander](#) )
2. Connect the yellow and gray wires of the sensor cable to the RS-485 to USB converter cable and plug it into your PC as illustrated in the figure below.
3. Connect a 9...28 VDC power supply to the USH-9.
4. Click on **Communication assistant** on the right-hand side of the Commander window and follow the instructions. During this procedure the communication assistant will search for connected devices. Upon successful completion, the new connection is added to the connections list (tab **Connections (F8)**).
5. In the **Communication** Section at the right-hand side of the Commander window select Mode **Connection** and the previously created connection from the drop-down list.
6. Click **Connect** to establish a connection with the USH-9. If the connection was successful a green icon is displayed at the top-right corner of the Commander window.
7. Select the tab **Parameters (F2)** and click **Download parameters from device** on the left side of the Commander window. The complete parameter list is transferred from the sensor to your PC and displayed in the **Parameter** window.

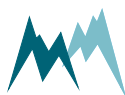
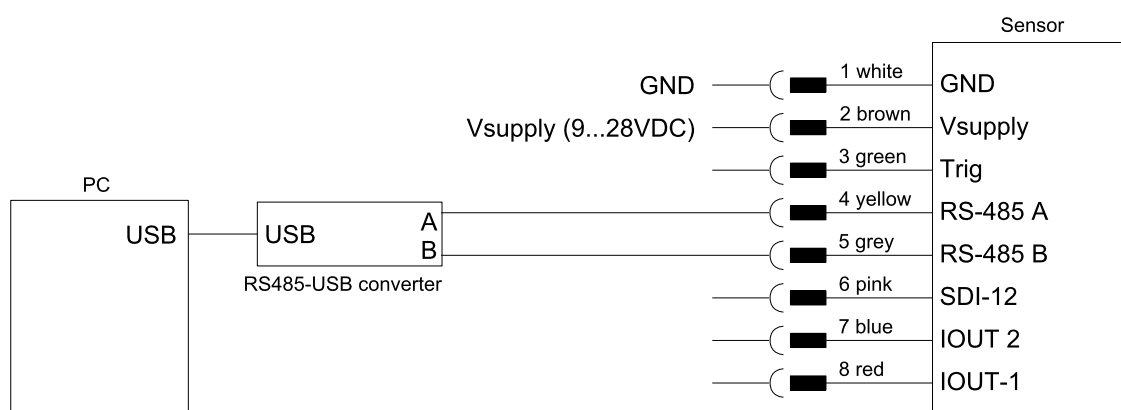

## 3.2 Configure the USH-9

1. Select language, decimal character, units and decimal places (see [General settings](#))
2. Select the measurement trigger (see [Measurement trigger](#))
3. Configure the USH-9 for the required application (see [Configuring the USH-9 for snow measurements](#) and [Configuring the USH-9 for water level measurements](#))
4. Define scope and structure of the data output (see [General settings](#))
5. Optional: Configure analog outputs (see [Analog output](#))
6. Send any modifications to the USH-9 by clicking [Upload modified parameters to device](#).

## 3.3 Acquire measurements

1. Establish a connection to your device as described in [Working with connections](#).
2. Download the setup of your device as described in [Download setup](#).
3. Select the [Measurement \(F3\)](#) tab.
4. In the [Commands](#) section click [Start polling measurement](#). Now, the Commander will trigger measurements of the USH-9 without any delays between measurements. The results are displayed [Measurement values](#) and plotted in the [Measurement data graph](#).
5. To finish polling mode click [Stop polling](#).

Commander 1.0.8.10

File Tabs Options Extra Help

Parameters (F2) Measurement (F3) Data (F4) Profile (F6) Stations (F7) Connections (F8) Terminal (F9)

Information

Device: SQ-Xa  
Protocol address: 0001  
Parameter: From file  
File name: retour Kunde-Auslieferungsparam  
Serial number: 24190325  
Setup version: 2.39.03  
Software:

Devices

SQ-Xa  
0001

Self-check

Code	Description	Cause	Solution
0	Sensor operates normally	-	-

Measurement values

ID	Name	Value	Unit
0	Self-check	0	
1	Level	49	mm
2	Velocity	1.003	m/s
3	Quality (SNR)	67.05	
4	Flow	5.143	m <sup>3</sup> /h
5	Flow sum		m <sup>3</sup>
6	Learned velocity	1.003	m/s
7	Learned flow	5.143	m <sup>3</sup> /h

Measurement data graph

Flow [m<sup>3</sup>/h]

2020-03-03 10:05:00 2020-03-03 10:10:00

Commands

Start and stop polling

Last measurement

Terminal

Authorization: Expert

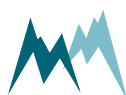

## 4 How the USH-9 works

The USH-9 is a sensor to measure distance contact-free. Ultrasonic pulses with a frequency of 50 kHz are emitted from the sensor-head and are reflected at any surface. The reflected signal is then detected by the sensor and from the travelling-time of the pulses the distance to the surface is calculated. [Figure 1](#) illustrates the path of the ultrasonic signal.

The ultrasonic pulses received by the sensor head are filtered for interferences and disturbing reflections, e.g. from precipitation. This permits reliable and accurate level measurements even during rain or snowfall, or when the snow is of very low density.

As the speed of sound depends on temperature, the USH-9 is equipped with an integrated Pt1000 air temperature sensor to automatically correct the measured distance and snow depth.

With the integrated, intelligent signal processing and the automatic switching between standby- and measurement-mode the power consumption can be minimized. With a 12-Ah battery the USH-9 can be operated for approx. 24 days with one measurement per minute.

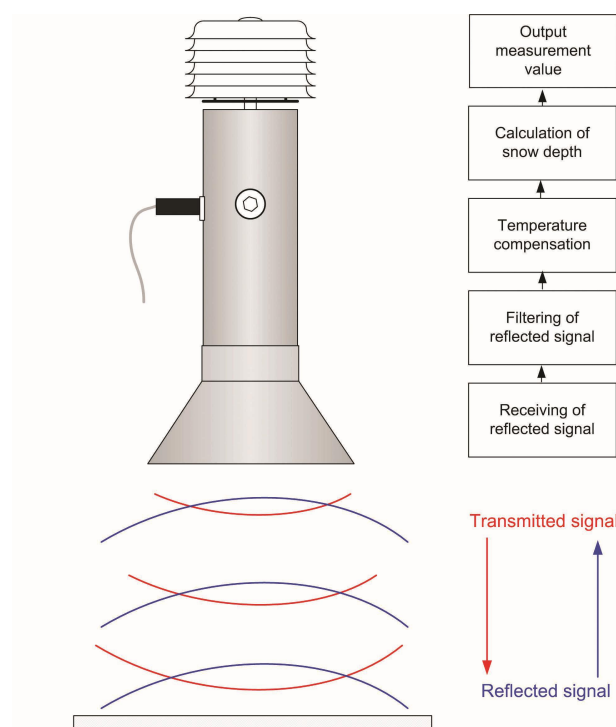

**Figure 1** Ultrasonic signal of the USH-9 sensor

# 5 Components

## 5.1 MAIN connector

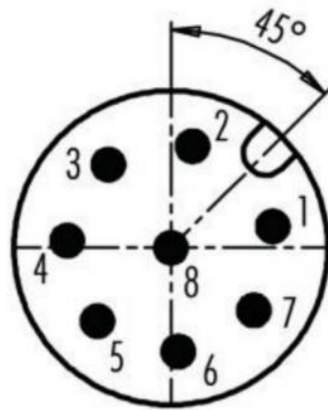

Figure 2 MAIN connector

	Pin	Colour <sup>1</sup>	Function	Description
Power supply	1	white	GND	Ground
	2	brown	Vsupply	9...28 VDC
Trigger input	3	green	Trig	low: 0...0.6 V, high: 2...27 V
RS-485 interface	4	yellow	RS485 A <sup>2</sup>	1 x RS-485 (1200...115200 Baud)
	5	grey	RS485 B <sup>2</sup>	
SDI-12 interface	6	pink	SDI-12	1 x SDI-12 (1200 Baud)
Analog outputs	7	blue	IOUT2	Temperature (4...20 mA)
	8	red	IOUT1	Snow depth (4...20 mA)



**NOTE** The analog outputs and the trigger input are referenced to GND on pin 1.

<sup>1</sup>Wire colour of the provided “Sommer” cable

<sup>2</sup>According to TI notation which differs from the standard EIA notation





## 6 Specifications

Snow depth measurement	
Measurement range	0...10 m
Near blanking distance	0.7 m
Accuracy	max. $\pm$ 1cm; typically 0.1% FS
Resolution	1 mm
Non-linearity	$\leq$ 0.15%
Measurement duration	2...20 s
Measurement interval	20 s...3 h
Measurement principle	Ultrasonic (frequency 50 kHz)
Beam aperture	12°

Temperature measurement	
Temperature sensor	Pt1000 with radiation shield
Measurement range	-40...60 °C (-40...140 °F)
Accuracy	0.3 °C
Resolution	0.01 °C

Power	
Power supply	9...28 VDC; Reverse voltage protection, overvoltage protection
Power consumption at 12 VDC	Sleep mode: <0.4 mA Active measurement: typically 40 mA (max. 300 mA for 0.05 s)

Interfaces	
Serial	RS-485 ASCII / Modbus RTU SDI-12
Analog	2 Analog outputs 4...20 mA (14 bit, max. load 250 $\Omega$ )

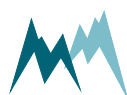

Physical and environmental	
Operating temperature	-40...60 °C (-40...140 °F)
Storage temperature	-40...60 °C (-40...140 °F)
Environmental humidity	0...100 %rH
Protection rating	IP 64
Lightning protection	Integrated protection against indirect lightning with a discharge capacity of 0.6 kV peak
Housing material	Anodized aluminium
Mounting bracket	Ø32...60 mm
Size Ø x H	Ø180 x 320 mm
Weight	1.2 kg

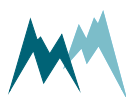

# 7 Installation

## 7.1 Site selection

The selection of a suitable site is crucial to gain accurate level and snow depth data that are representative of the monitored area. Several aspects have to be considered when choosing a site, especially for snow depth measurements:

1. The measurement spot should be representative of the monitored area. This applies to the weather conditions as well as to the ground surface. Different surfaces, e.g. grass and gravel, have different thermal properties and consequently influence snow accumulation and snow melt.
2. The terrain should be flat or only be slightly sloping. There should be no troughs or hills.
3. There should be no boulders, trees, fences or other objects on and around the measurement spot. Any obstacle can cause snow drift and thus affect the snow depth measurement.
4. The site should be exposed to wind as little as possible.
5. The site must be safe from avalanches.
6. If the measurement spot is on or near a slope any snow gliding has to be ruled out.

## 7.2 Things to consider for installation

The USH-9 can be mounted to a horizontal tube with the included bracket (max. tube diameter 60 mm) as shown in [Figure 3](#).

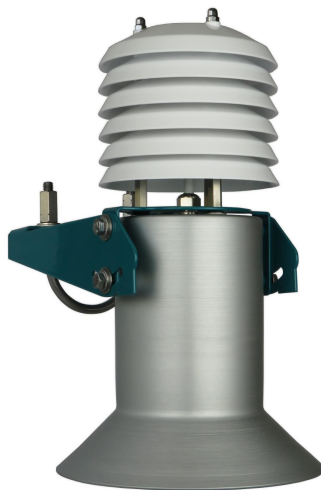
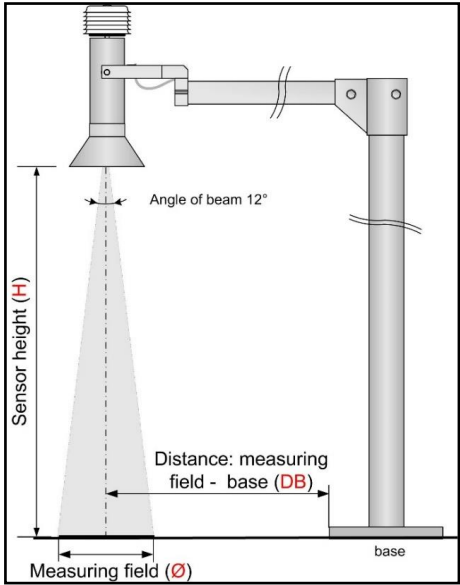

Figure 3 USH-9 with mounting bracket

When planning the installation of a USH-9 the extension of the cone-shaped measurement beam has to be taken into account. The higher the sensor is mounted the bigger the diameter of the measurement spot. Consequently, the mast and cross-beam must be designed in such a way that they do not interfere with the ultrasonic beam and thus create unwanted reflections. The same applies to river banks and channel walls in water level applications. Consult the table in Figure 4 for recommended distances between mast and measurement spot.



H [m]	Ø [m]	DB [m]
2	0.4	1.0
3	0.6	1.2
4	0.8	1.4
5	1.1	1.6
6	1.3	1.8
7	1.5	2.0
8	1.7	2.2

Figure 4 Measurement spot and USH-9 position

It is recommended to mount the USH-9 one meter above the maximum expected level and minimum 3 m above ground. The maximum mounting height is 10.5 m above ground. As an accessory, Sommer provides a 1.6 m long, rotatable cross-arm for easy sensor mounting.

If a snow-depth monitoring site needs to be secured by a fence, the distance between the fence and the USH-9 should be large enough to avoid snow build-up or snow drift.

**7.2.1 Power supply**

The USH-9 is designed for extreme environmental conditions at remote sites and with no grid connection. The sensor switches automatically into standby-mode between measurements and thus consumes only approx. 0.2 Ah per day which can be supplied by a 12V-solar-generator mounted to the mast.

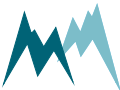

## 7.2.2 Signal cables

### Maximum cable length

Please consider the maximum cable lengths for the applied transmission protocol:

Protocol	Max. cable length [m]
SDI-12	60
RS-485	300

Table 1 Maximum cable lengths



**NOTE** Cable lengths longer than 60 m require a heavier gauge wire if the power supply drops below 11 V.

## 7.2.3 Lightning protection

If the underground at the measurement site permits sufficient current dissipation it is strongly recommended to equip the sensor support or mast with properly dimensioned lightning protection. Consult an expert for advice.

The USH-9 is protected against overvoltage. If a data logger is mounted to the mast, its ground lug must be properly connected to earth ground.

## 7.3 Required tools and equipment

Prepare the following tools and equipment to install the USH-9:

Qty	Tool
1	Mounting tube $\varnothing 32 \dots 60$ mm
1	Flat spanner 13 mm
1	Wire cutter
several	Cable ties

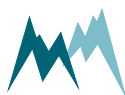

## 7.4 Mounting

1. Slide the USH-9 over the mounting tube and tighten the U-bolt.  
For accurate measurements the USH-9 should be mounted within  $\pm 6^\circ$  perpendicular to the snow/ ground surface.



### ATTENTION

If the measurement spot is sloping, make sure the USH-9 is mounted perpendicular to the snow/ground surface! Also, do not install the USH-9 on a horizontal podium in the slope!

Never tilt the USH-9 towards the base of the mast as this can cause unwanted reflections. To avoid such a situation, consider rotating the mast or selecting another measurement spot.



**NOTE** The distance between the USH-9 and the snow surface should be  $> 2$  m. This ensures that precipitation can be detected properly and the rate of change filter operates correctly.

2. Connect the signal cable to the USH-9 and route it to the location of the data acquisition unit.  
Fix the cable with cable ties.

## 7.5 Wiring

### 7.5.1 RS-485

Connect the USH-9 to a data logger or RS-485 network according to the figure below.

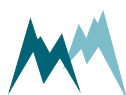

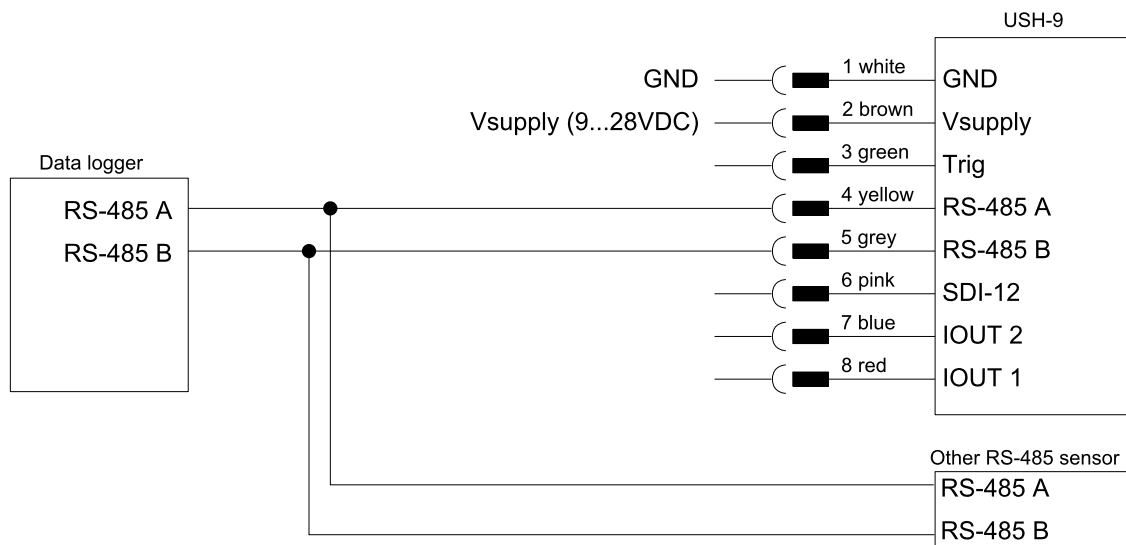

## 7.5.2 SDI-12

Connect the USH-9 to a data logger by SDI-12 according to the figure below.

SDI-12 uses a shared bus with a ground wire, a data wire (indicated as SDI-12) and an optional +12 V wire.



**NOTE** The connection with the 12 V power supply is optional and depends on the connected SDI-12 master device (typically a data logger).

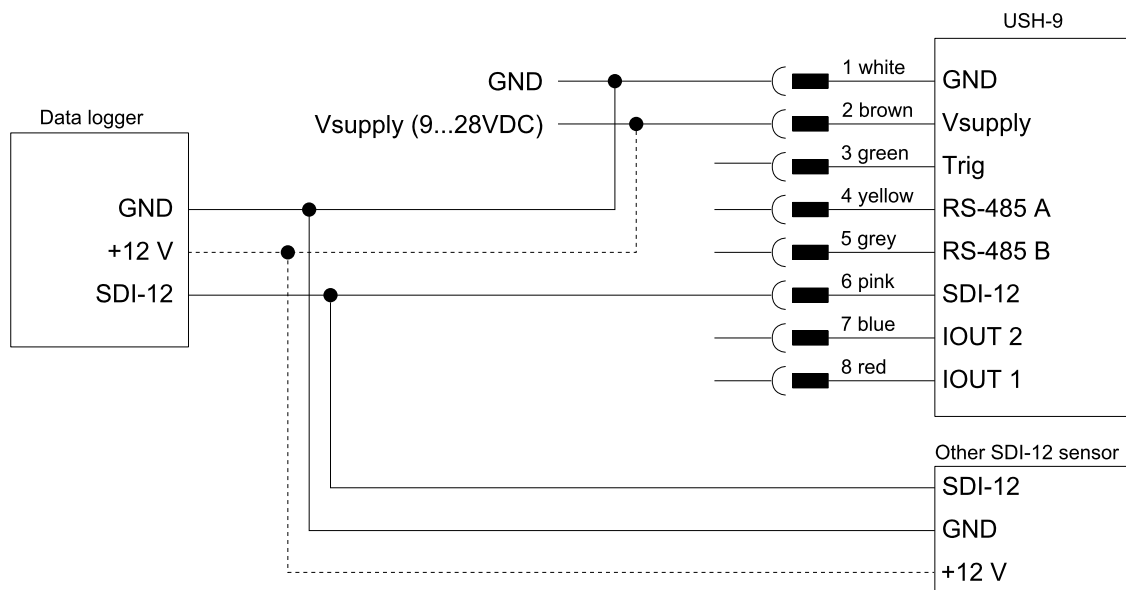
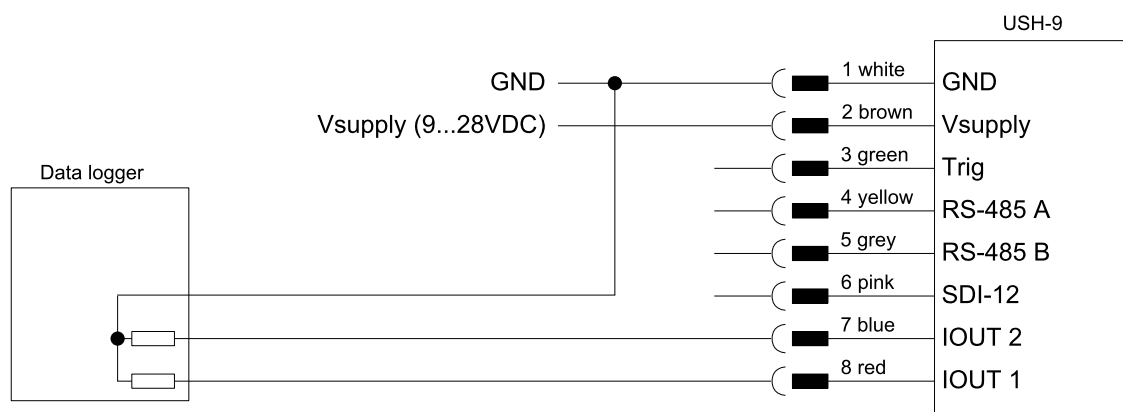

Figure 5 Wiring of the USH-9 with a data logger via SDI-12

### 7.5.3 How to wire analog outputs

Connect the analog outputs of the USH-9 to a data acquisition device according to the figure below.



**NOTE** If a data logger is connected to the IOUT outputs, the resistance of the logger input(s) must not exceed 470  $\Omega$ .

## 7.6 Testing

Perform the following steps to verify the distance measurement:

1. Select the **Parameter (F2)** tab and open the menu **Level and distance**.
2. Click the button **Level/distance test**.
3. Note the distance value displayed in the pop-up window.
4. Place a flat object with known height, e.g. wooden board on a pallet, on the ground underneath the USH-9.
5. Repeat the **Level/distance test** and note the new distance.
6. Verify that the difference of the measured distances equals the height of the object on the ground.

## 7.7 Adjustment

Perform the following steps to adjust the level measurement:

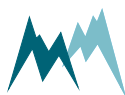



1. Select the **Parameter (F2)** tab and open the menu **Level and distance**.
2. Click the button **Adjust level**.
3. After the measurement has completed, enter the correct level in the pop-up window and press enter.
4. Repeat the **Level/distance test** and verify the reading.

## 7.8 Start-up

After successful testing, verify that the measurement data are recorded by your data acquisition system and check the data transmission to the remote server if applicable.



# 8 Operation

## 8.1 Connect device to PC

1. Install the Commander support software (see [Installation of Commander](#) )
2. Connect the yellow and gray wires of the sensor cable to the RS-485 to USB converter cable and plug it into your PC as illustrated in the figure below.
3. Connect a 9...28 VDC power supply to the USH-9.
4. Click on **Communication assistant** on the right-hand side of the Commander window and follow the instructions. During this procedure the communication assistant will search for connected devices. Upon successful completion, the new connection is added to the connections list (tab **Connections (F8)**).
5. In the **Communication** Section at the right-hand side of the Commander window select Mode **Connection** and the previously created connection from the drop-down list.
6. Click **Connect** to establish a connection with the USH-9. If the connection was successful a green icon is displayed at the top-right corner of the Commander window.
7. Select the tab **Parameters (F2)** and click **Download parameters from device** on the left side of the Commander window. The complete parameter list is transferred from the sensor to your PC and displayed in the **Parameter** window.

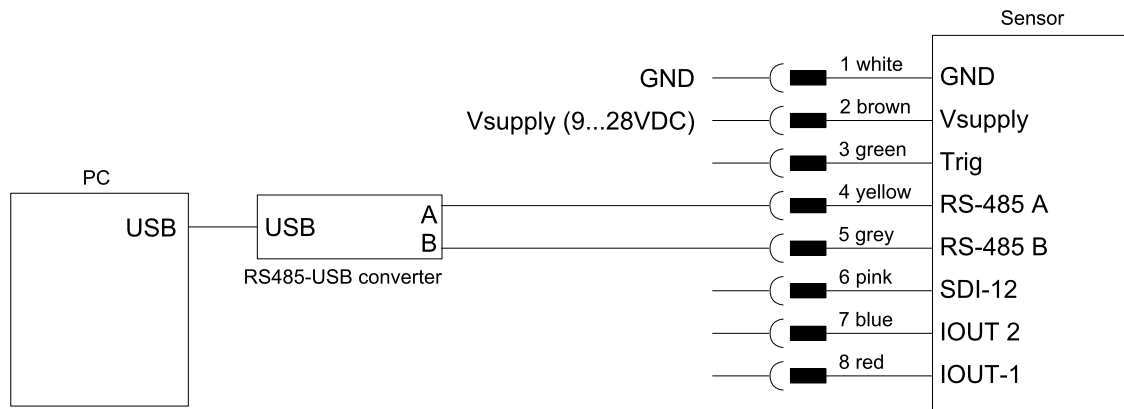

To activate the communication between your device and the Commander software follow the steps described in [Working with connections](#).

## 8.2 How do I test the USH-9 indoors?

To test the USH-9 and to verify its distance/level measurements turn the device upside down so that it is facing the ceiling of a room. Now, click the button **Level/distance test** in the **Level and distance**

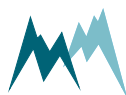

menu. The USH-9 then triggers a measurement and returns the current distance and level.

Place a sturdy, flat object (e.g. book) underneath the USH-9 and perform additional measurements to check a second distance/level.



**ATTENTION** If the USH-9 is configured for snow applications do not use the general measurement function (**Measurement (F3)**-tab) of the Commander! The snow application mode has a measurement filter (Rate of change filter, RoC) that suppresses abrupt level changes. Thus, it may take some time for the USH-9 to read the actual distance.



## 9 Maintenance

The USH-9 generally does not require any special maintenance. However, the device should be inspected occasionally for damage and a dirty sensor surface. To remove dirt use a wet cloth with little force. Do not use any abrasive detergent or scraping tool!

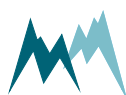

# 10 Support software Commander

## 10.1 Software features

The Commander is a multipurpose software tool to configure and operate any Sommer Messtechnik device. It offers the following functions:

- Communication with Sommer Messtechnik sensors and data loggers via serial connection, modem, socket, IP-call and Bluetooth®
- Management of connections and stations
- Configurations of sensors and data loggers
- Live data monitoring and storage
- Data management including download from data loggers and transmission to MDS (Measurement Data server)
- Terminal window to check data transfer and to access device settings directly

## 10.2 System requirements

The Commander software supports 32- and 64-bit versions of Windows 7 SP1, Windows 8, Windows 8.1 and Windows 10.

For correct operation Microsoft® .NET Framework 4.5 or later must be installed.

## 10.3 Installation of Commander

Follow the steps below to install the Commander software:

1. Plug the USB stick shipped with the device into your PC.
2. Double-click the `commander.msi` installer file on the USB drive.
3. Click **Next** on the pop-up window

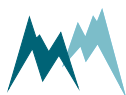



4. Read the instructions and click [Next](#)

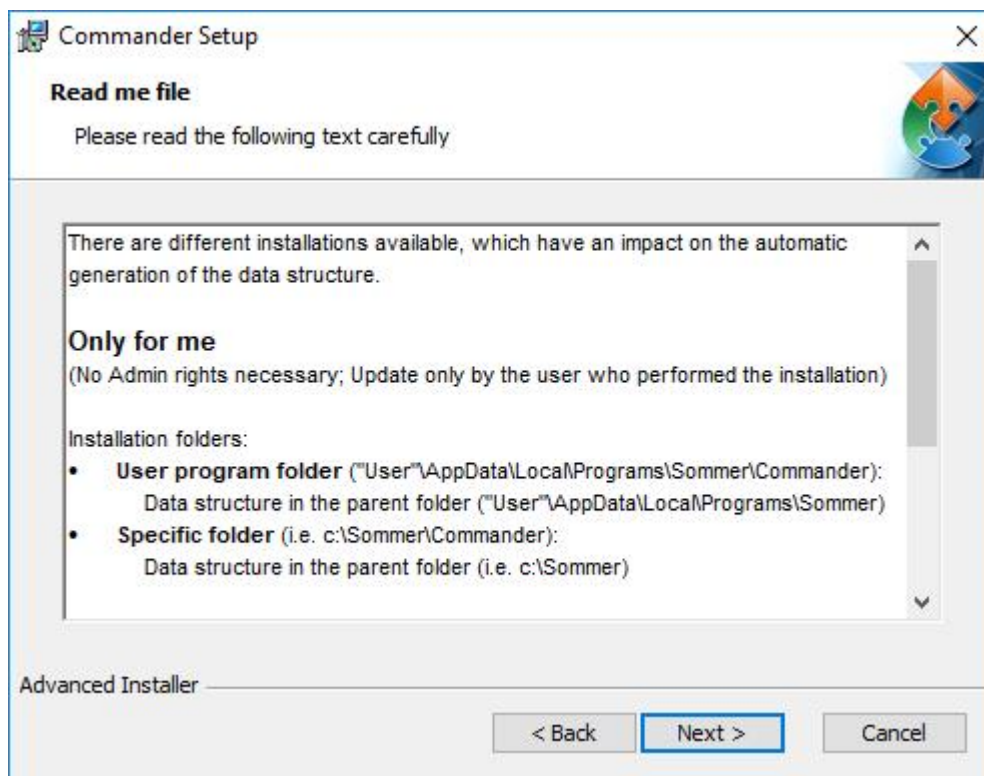

5. Select the installation type and click [Next](#)

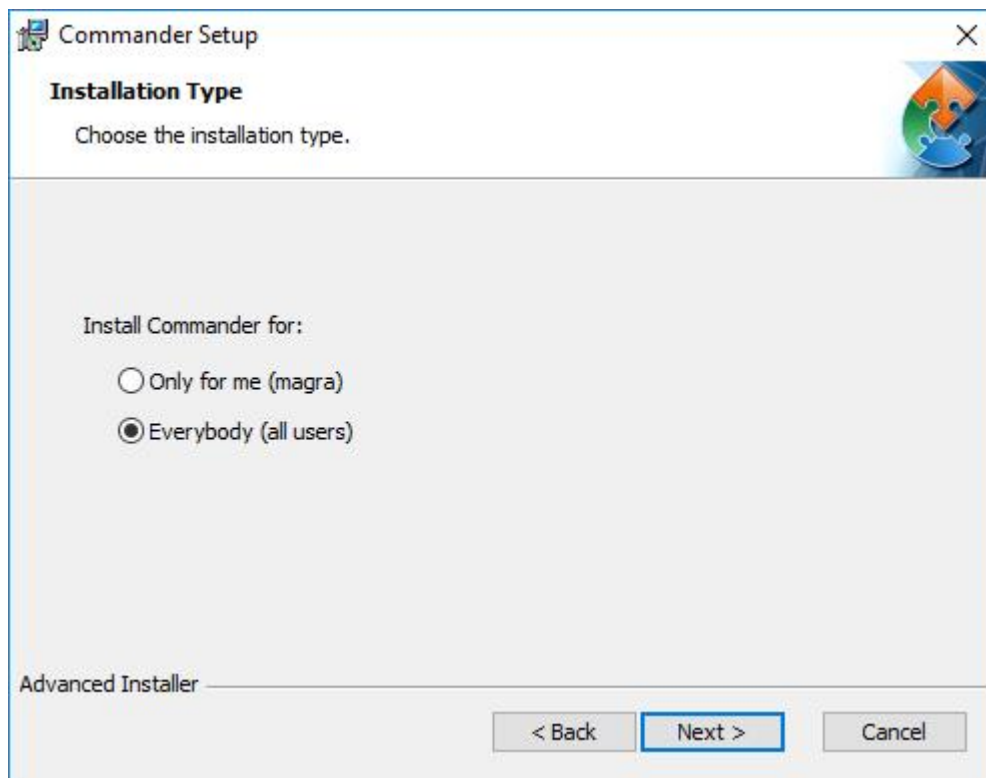

#### NOTE

Two installation types are available. Depending on the selection, the access rights and the folder structure differ:

##### **Only for me**

No admin rights are required. Updates are only available to the user who installed the software.

Installation folders:

- User program folder:  
Users\User\AppData\Local\Programs\Sommer\Commander
- Data structure:  
Users\User\AppData\Local\Programs\Sommer

- Specific folder (default):  
C:\Sommer\Commander
- Data structure (default):  
C:\Sommer

##### **Everybody**

Admin rights are required. Updates may only be performed by system administrators.

Installation folders:

- Standard program folder:  
Program Files (x86)\Sommer\Commander

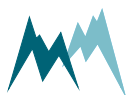



Data structure:

Users\Public\Public documents\Sommer

- Specific folder (default):

C:\Sommer\Commander

Data structure (default):

C:\Sommer

6. Select the installation directory and click **Next**.

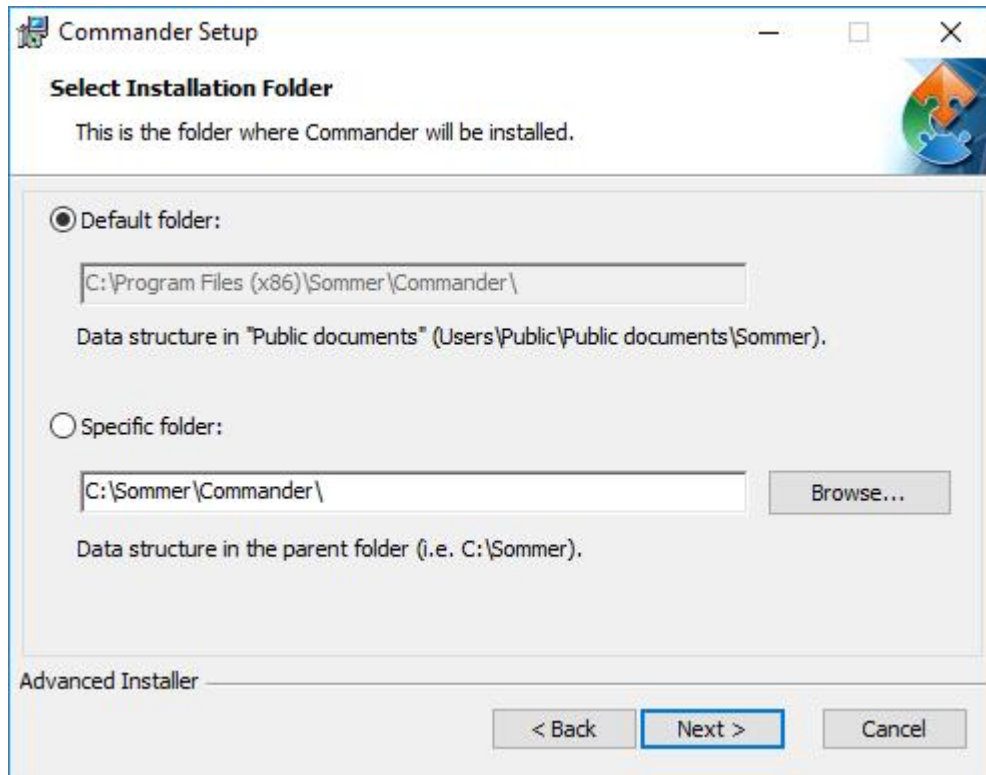

7. Select the features to be installed and click **Next**.

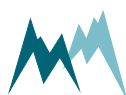



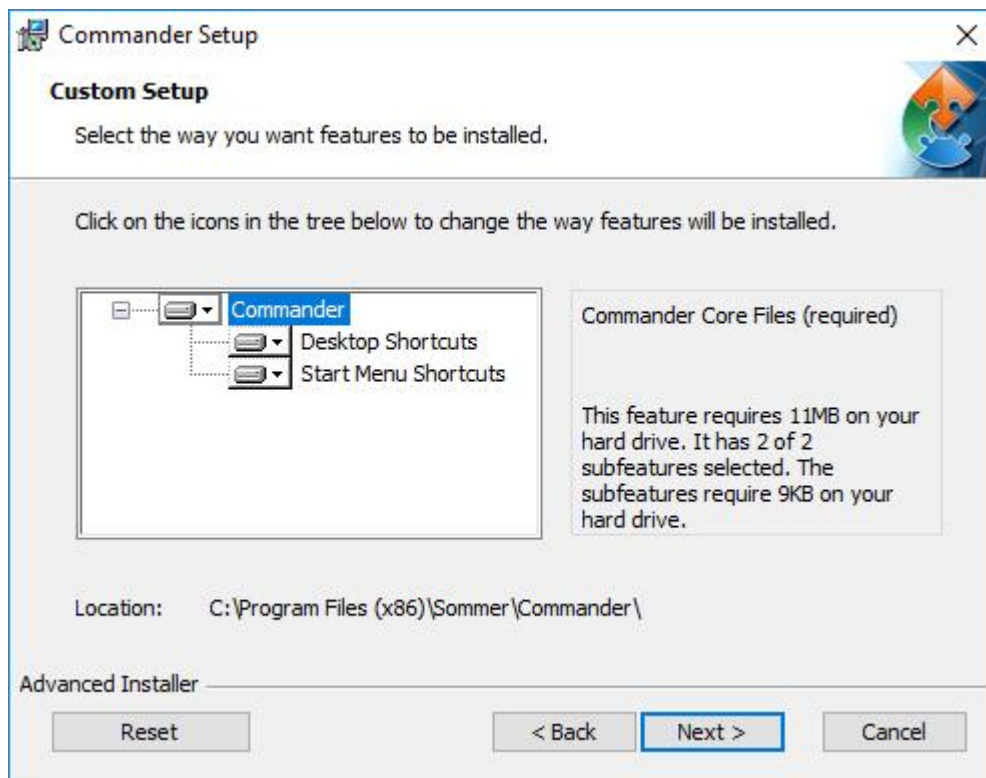

8. Click **Install** to start the installation.

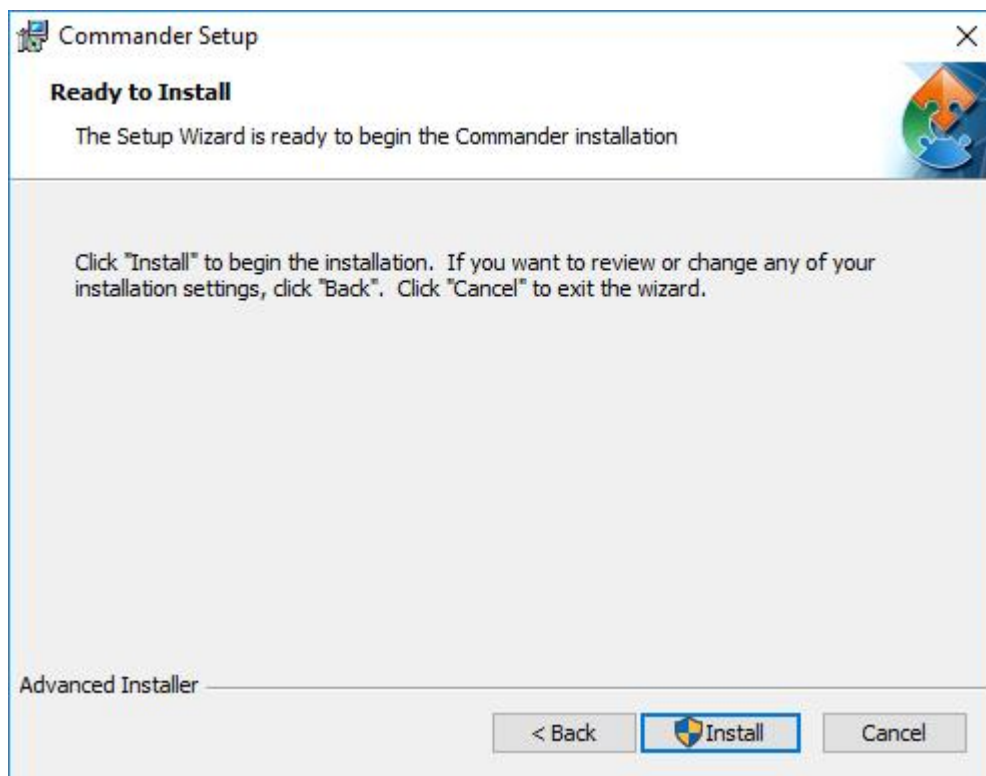

9. Click **Finish** to complete the installation.

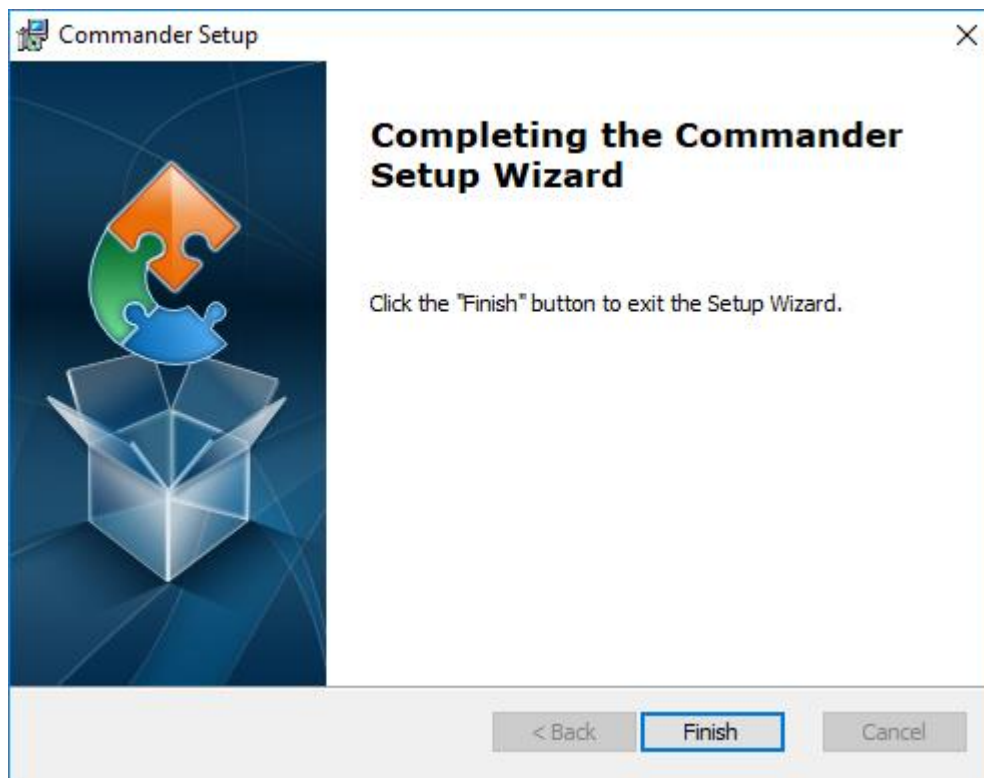

## 10.4 Working with connections

### 10.4.1 Establish a connection with the Communication assistant

1. Install the Commander support software as described in [Installation of Commander](#).
2. Connect the device to your PC according to [Connect the USH-9 to your PC](#).
3. Start the Commander software on your PC.
4. Click on [Communication assistant](#) on the right-hand side of the Commander window and follow the instructions. During this procedure the communication assistant will search for connected devices. Upon successful completion, the new connection is added to the connections list (tab [Connections \(F8\)](#)).
5. In the [Communication](#) Section at the right-hand side of the Commander window select Mode [Connection](#) and the previously created connection from the drop-down list.
6. Click [Connect](#) to establish a connection with the USH-9. If the connection was successful a green icon is displayed at the top-right corner of the Commander window.

To view the settings of the connected device or to read the current measurements, follow the steps described in [Download setup](#) and [Record measurements](#).

## 10.4.2 Establish a connection manually

1. Install the Commander support software as described in [Installation of Commander](#).
2. Connect the device to your PC according to [Connect the USH-9 to your PC](#).
3. Start the Commander software on your PC.
4. Select the required connection in the [Connections](#) list of the [Connections \(F8\)](#) tab and click [Connect](#). If the connection was successful a green icon is displayed at the top-right corner of the Commander window.

If you don't have the required connection available in the [Connections](#) list, create a new connection as described in [Create a new connection](#).

To view the settings of the connected device or to read the current measurements, follow the steps described in [Download setup](#) and [Record measurements](#).

## 10.4.3 Create a new connection

1. Select the [Connections \(F8\)](#) tab in the Commander.
2. Click [New connection](#).
3. In the section [Connection settings](#) enter a name of the new connection, e.g. *Serial-com1-9600*, and the connection type, e.g. *Serial connection*.
4. Enter the required information for the selected connection type.  
If your USH-9 is wired to your PC with a RS-485 to USB converter cable, select the port where the device is connected and select a Baud rate of 9800.

## 10.5 Working with stations

### 10.5.1 Create a station with the Communication assistant

In order to manage several data loggers, to connect to a data logger via IP-call and to download data, stations can be created in the Commander software. To view a list of all stations select the tab [Stations \(F7\)](#).

Perform the following steps to create a new station with the [Communication assistant](#):

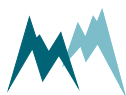

1. Click on **Communication assistant** in the Commander-window

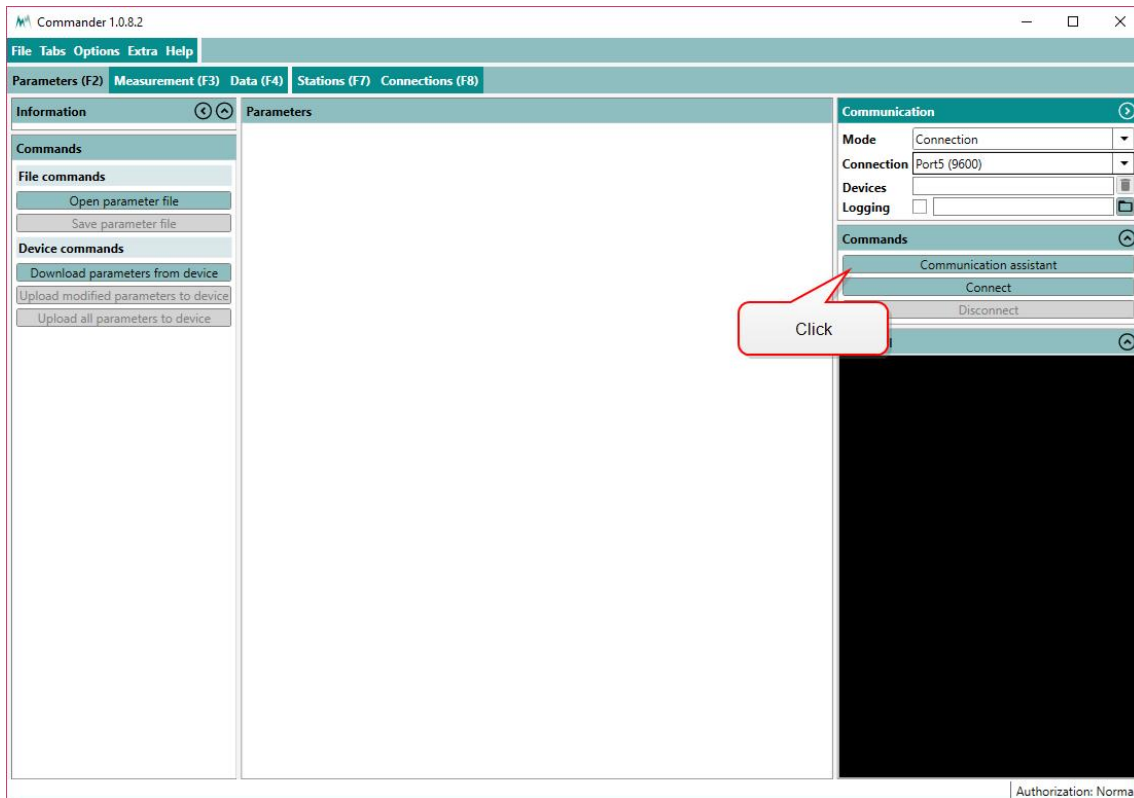

2. In the pop-up window choose the required connection and click **Next**.

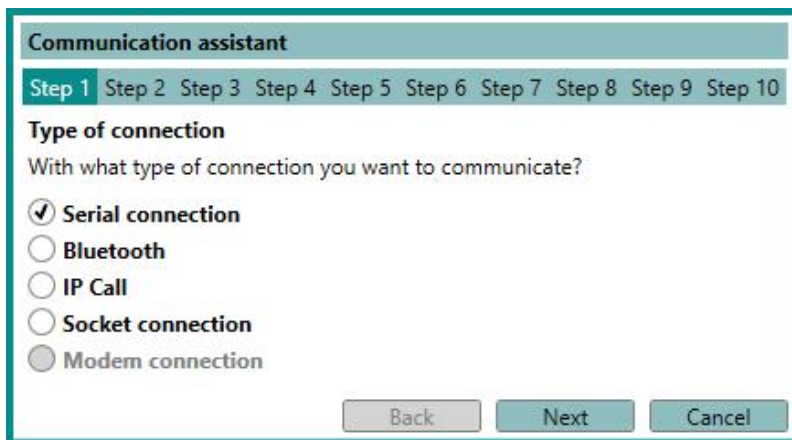

3. Verify that the USH-9 is connected to your PC and a power supply. Click **Next**.

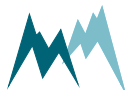

**Communication assistant**

Step 1 Step 2 Step 3 Step 4 Step 5 Step 6 Step 7 Step 8 Step 9 Step 10

**Serial connection: Device fully functional?**  
 Make sure that the device is connected and supplied.  
 Click "Next" to proceed.

Back Next Cancel

4. Select *Logger (115200 Bd)* and click *Next*.

**Communication assistant**

Step 1 Step 2 Step 3 Step 4 Step 5 Step 6 Step 7 Step 8 Step 9 Step 10

**Serial connection: Device type**  
 With what type of device you want to communicate?

**Logger (115200 Bd)** (MRL-6, MRL-7, RQ-30 ADMS)  
 **Sensor (9600 Bd)** (RQ-30, RG-30, SQ-X, DuoVQ, SPA-2)

Or should a port be checked with changing settings?  
 **Check port** Baud rate, Parity and stop bits

Back Next Cancel

5. Select *Scan ports* and click *Next*.

**Communication assistant**

Step 1 Step 2 Step 3 Step 4 Step 5 Step 6 Step 7 Step 8 Step 9

**Serial connection: Connection**  
 Do you want to communicate with an existing or new connection?

**Baud rate** 115200

**Existing connection**  
 Connection Port9 (115200) ▾

**New connection**  
 Select port 09 ▾  
 Scan ports

Back Next Cancel

6. The Commander now scans all available ports.

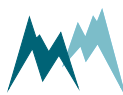

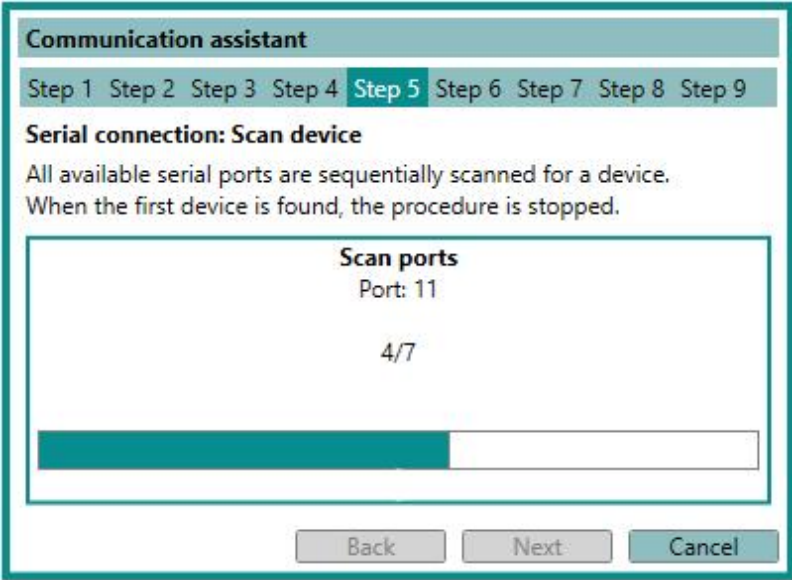

7. Adopt the *Name* provided by the communication assistant. Click *Next*.

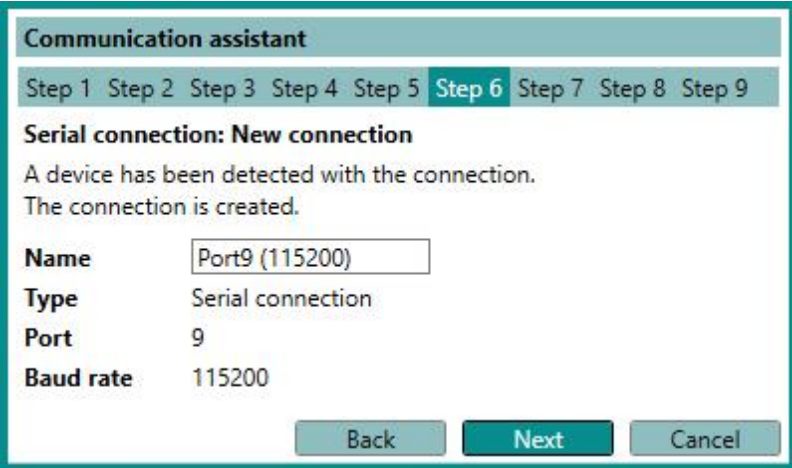

8. The Commander now scans the selected port for connected devices.

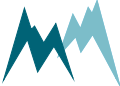

**Communication assistant**

Step 1 Step 2 Step 3 Step 4 Step 5 Step 6 **Step 7** Step 8 Step 9

**Serial connection: Scan devices**  
All available devices are scanned.

**Scan devices**  
Scan all devices "0099" in level "1"

**Devices**

0000 41/2

12/15

9. Adopt the *Name* of the new station or enter a new name. Click *Next*.

**Communication assistant**

Step 1 Step 2 Step 3 Step 4 Step 5 Step 6 Step 7 **Step 8** Step 9

**New station**  
No matching station has been found.  
Changes of the station number are performed on the device as well.

**Station ID** 05170012

**Station number**

**Name**

**Devices**

**Do you want to save the station?**

10. A new station has now been created. Click *Finish*.

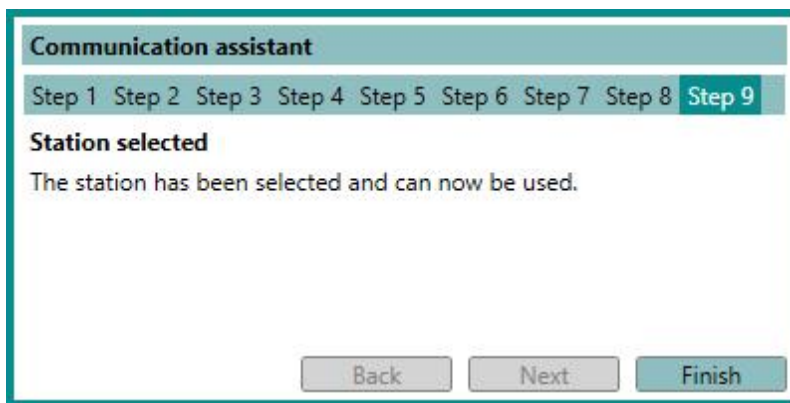

11. The newly created station can now be selected in the **Communication** section of the Commander. Click **Connect** to activate the connection to your device.

## 10.5.2 Create a station manually

In order to manage several data loggers, to connect to a data logger via IP-call and to download data, stations can be created in the Commander software. To view a list of all stations select the tab **Stations (F7)**.

Perform the following steps to create a new station:

1. In the tab-menu **Stations (F7)** click **New station**.
2. Under **Station settings** enter the **Station number** and **Sommer ID**. By default both settings are set to the device's serial number (visible on the USH-9 housing).
3. Select the **Connections** used for the station. Multiple selections are possible; the default connection can be selected by ticking the circular field.
4. Depending on the connection type, enter the additional information, e.g. **Address** for a Bluetooth connection or **IMSI number** for an IP call.
5. Enter the settings for **Data** management. When data are downloaded from a connected USH-9 they are stored in an archive-file by default. Each archive-file contains the data of a year or month, as selected in **Archive type**. Selection **None** will save all data in one file. The default location for data files is C:\Users\Public\Documents\Sommer\Data\.
6. Save the newly created station with the button **Save station**.

## 10.6 Working with measurements

### 10.6.1 Poll continuous measurements

1. Establish a connection to your device as described in **Working with connections**.
2. Download the setup of your device as described in **Download setup**.

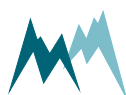



3. Select the **Measurement (F3)** tab.
4. In the **Commands** section click **Start polling measurement**. Now, the Commander will trigger measurements of the USH-9 without any delays between measurements. The results are displayed **Measurement values** and plotted in the **Measurement data graph**.
5. To finish polling mode click **Stop polling**.

Commander 1.0.8.10

File Tabs Options Extra Help

Parameters (F2) Measurement (F3) Data (F4) Profile (F6) Stations (F7) Connections (F8) Terminal (F9)

Information

Device: SQ-Xa  
 Protocol address: 0001  
 Parameter: From file  
 File name: retour Kunde-Auslieferungsparm  
 Serial number: 24190325  
 Setup version: 2.39.03  
 Software: 1.0.8.10

Devices

SQ-Xa  
0001

Self-check

Code	Description	Cause	Solution
0	Sensor operates normally	-	-

Measurement values

ID	Name	Value	Unit
0	Self-check	0	
1	Level	49	mm
2	Velocity	1.003	m/s
3	Quality (SNR)	67.05	
4	Flow	5.143	m <sup>3</sup> /h
5	Flow sum		m <sup>3</sup>
6	Learned velocity	1.003	m/s
7	Learned flow	5.143	m <sup>3</sup> /h

Measurement data graph

Flow [m<sup>3</sup>/h]

2020-03-03 10:05:00 2020-03-03 10:10:00

Terminal

Authorization: Expert



**NOTE** The polling mode stops automatically after 30 minutes.

## 10.6.2 Record measurements

1. Establish a connection to your device as described in [Working with connections](#).
2. Download the setup of your device as described in [Download setup](#).
3. Select the **Measurement (F3)** tab.
4. If the connection with your device is active, the data will now be displayed in the measurement table and updated at the interval specified in the setup. Also, the incoming data strings are displayed in the **Terminal**.
5. Click **Save measurement data** in the **Commands** section to save the recorded measurements. The data are saved as a \*.csv file in the SommerXF format.



**NOTE** You can change the scope of the data output in the setup [OP, information](#).

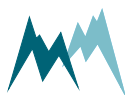

## 10.7 Working with data

### 10.7.1 View live data

Follow the steps below to view live data acquired from your device:

1. Establish a direct or remote connection with the USH-9 using the Commander. Use an existing Commander-connection or -station if available.
2. In the **Parameters (F2)** tab download the parameters of the USH-9.
3. Now, there are two options to view the measurement data:
  1. If **OP, measurement output** is set to *measured automatic*, data are displayed in the **Measurement (F3)** tab in the specified measurement interval.
  2. Open the **Measurement (F3)** tab and click **Start polling measurements**. With this option measurements are triggered in the fastest possible sequence and the results are displayed instantly. This measurement mode can be stopped by clicking **Stop polling**, or it is finished automatically after 30 minutes.

## 10.8 Working with spectra

### 10.8.1 Record spectrum

1. Establish a connection to your device as described in [Working with connections](#).
2. Download the setup of your device as described in [Download setup](#).
3. Select the **Measurement (F3)** tab.
4. Click **Start spectrum mode** in the **Commands** section. Now the Commander collects the spectrum data and displays them in **Spectrum graph**.



**NOTE** The collection of the spectrum data may require some time.

5. Click **Save spectrum file** in the **Commands** section to save the recorded spectra. The data are saved as a \*.xlms file.



**NOTE** The number of acquired spectra is displayed at the bottom of the **Spectrum graph**. You can navigate through the spectra by clicking the navigation buttons.

6. Click **Stop spectrum mode** to quit recording spectra.

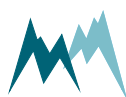

## 10.8.2 Read spectrum file

1. Open the Commander.
2. Click [Open spectrum file](#) in the [Commands](#) section.
3. Select the desired spectrum file (\*.xmls) and click [Open](#). The spectra are now opened and displayed in the [Spectrum graph](#).



**NOTE** The number of acquired spectra is displayed at the bottom of the [Spectrum graph](#). You can navigate through the spectra by clicking the navigation buttons.

## 10.9 Working with parameter (setup) files

### 10.9.1 Download setup

1. Establish a connection to your device as described in [Working with connections](#).
2. Select the [Parameters \(F2\)](#) tab in the Commander software.
3. In the [Commands](#) section click [Download parameters from device](#).

The Commander now downloads the setup currently active on the USH-9. This may take some time if you are downloading the setup for the first time to your PC. Consecutive downloads of a setup with the same version number are usually faster.

You can now save the setup file by clicking [Save parameter file](#), or edit the settings as described in [Edit setup](#).



**TIP** Save the setup on your PC before you make any changes!

### 10.9.2 Open a setup file

1. Start the Commander on your PC and connect to your USH-9 either directly with the USB to RS485 isolated converter cable or, if available, the optional Bluetooth connection.
2. Open the [Parameters \(F2\)](#) tab and click [Open parameter file](#). Select the required file (extension .xml or .xmla).
3. Verify the new settings and click [Upload all parameters to device](#). After completion the new settings are active on your data logger.

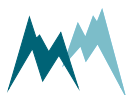

### 10.9.3 Edit setup

1. Open the setup file as described in [Open a setup file](#) or download it from your device as described in [Download setup](#).
2. Adapt the values of the settings in question and press Enter after each. After you have changed a value, its text box will turn red.



**NOTE** If you have entered a value outside the data range of the setting, it will be forced to the next valid value! The valid range of each setting is listed in the [Parameter definitions](#).

3. After you have adapted all required settings save the setup file and/or upload the setup to your device by clicking [Upload modified parameters to device](#).  
Once the setup has been saved or uploaded, the modified red text boxes will turn white again, indicating that the settings have been saved/applied.

### 10.9.4 Upload new setup file

1. Establish a connection to your device as described in [Working with connections](#).
2. Select the [Parameters \(F2\)](#) tab.
3. Download the setup currently on the USH-9 as described in [Download setup](#) and save it by clicking [Save parameter file](#). This step is recommended to have the latest setup available for documentation.
4. Click [Open parameter file](#) and select the required setup file (\*.xImp) on your PC.
5. Click [Upload all parameters to device](#). This transfers the current setup to the USH-9.
6. To verify the correct upload click [Download parameters from device](#). This will display the present setup of the USH-9.

## 10.10 Update firmware

1. Connect the USH-9 to your PC with the USB to RS485 isolated converter cable and make sure the device is powered.
2. Click on the menu item [Extra](#) and select [Start Programmer](#).
3. Select the firmware file (\*.hex) provided by SOMMER Messtechnik. Make sure the file is stored on your PC and not on a USB or network drive.
4. Choose the COM-port the data logger is connected to and a Baud-rate of 57'600.
5. Perform the following three steps in short sequence:

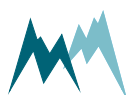

- Click **Program**
- Unpower the data logger
- Wait 3...5 seconds
- Repower the data logger

The firmware currently present on the data logger is now erased and the new one copied to the data logger. During the update process the pop-up window may show the following messages:

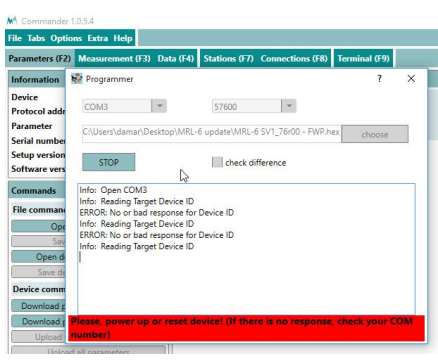

The programmer is not ready; power needs to be on.

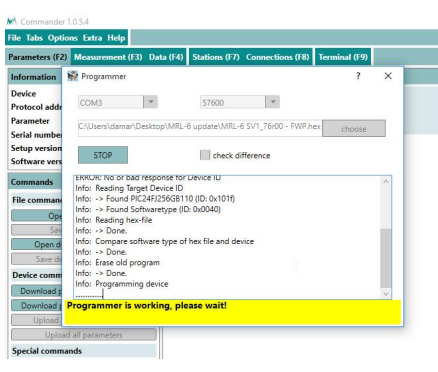

The programmer is active.

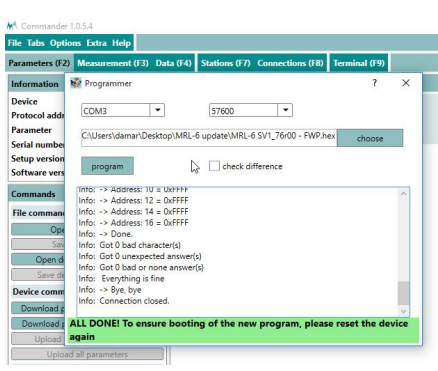

The firmware update has finished.

6. Close the programmer-window as soon as the firmware update has finished.
7. Switch off and repower the data logger again.
8. Open the **Parameters (F2)** tab.



9. Click [Download parameters from device](#). The download of the new parameter list might take a few minutes. After completion the new firmware and setup versions will be displayed in the [Information](#) section.

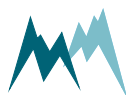

# 11 Configuration of the USH-9

## 11.1 Software tools

The USH-9 can be configured with one of the following tools:

- Configuration with Commander support software
- Configuration with a terminal program

## 11.2 Configuration with Commander support software

Follow the steps below to modify the configuration parameters of the USH-9:

1. Establish a connection between your PC and the USH-9 as described in [Connect the USH-9 to your PC](#).
2. Select the tab **Parameters (F2)** and click **Download parameters from device**. The complete parameter list is transferred from the sensor to your PC and displayed in the Parameter window.

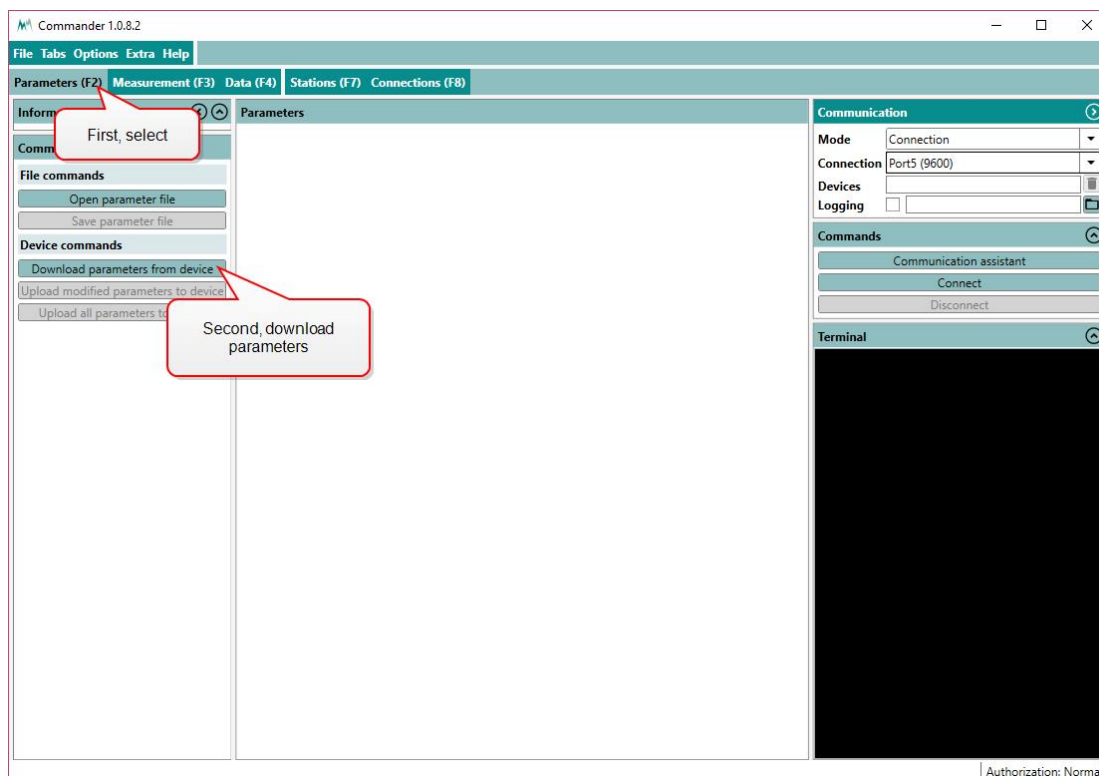



**NOTE** The first download of the parameter list may take a few minutes. After that the device is known to the PC and consecutive downloads are much faster.

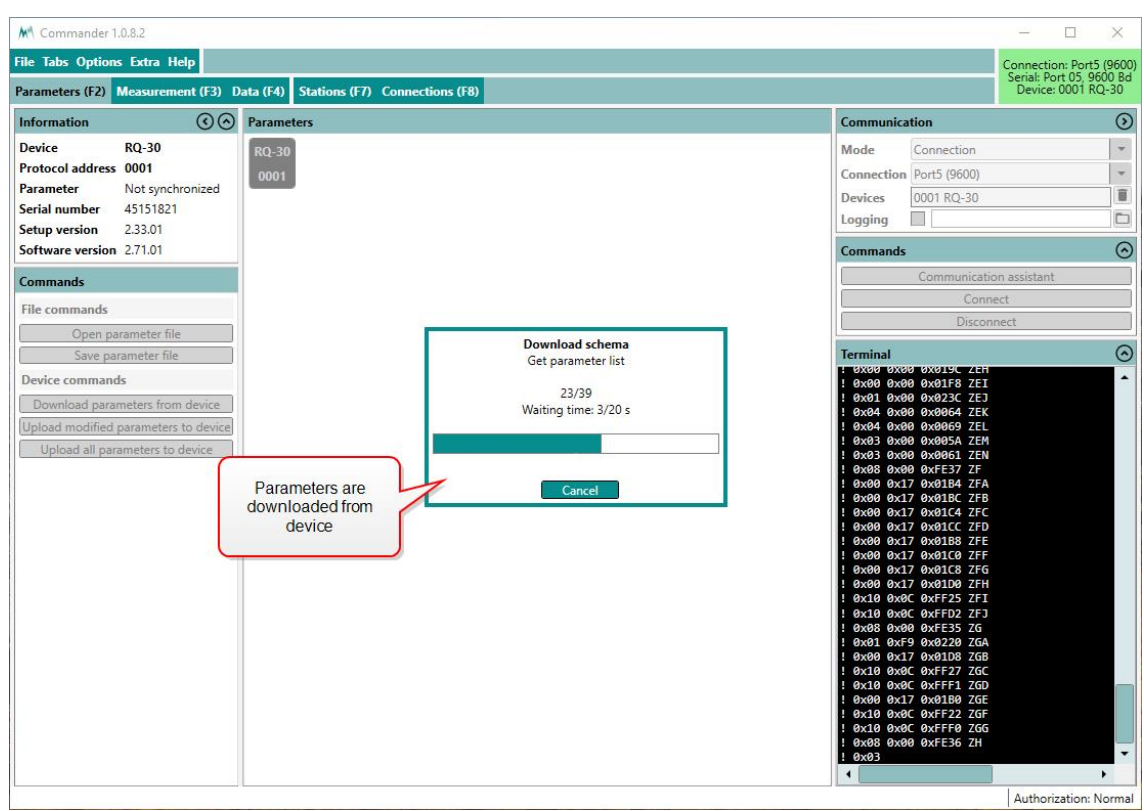

3. Save the parameter file to your PC by clicking **Save parameter file**. This step is recommended to track any configuration changes.





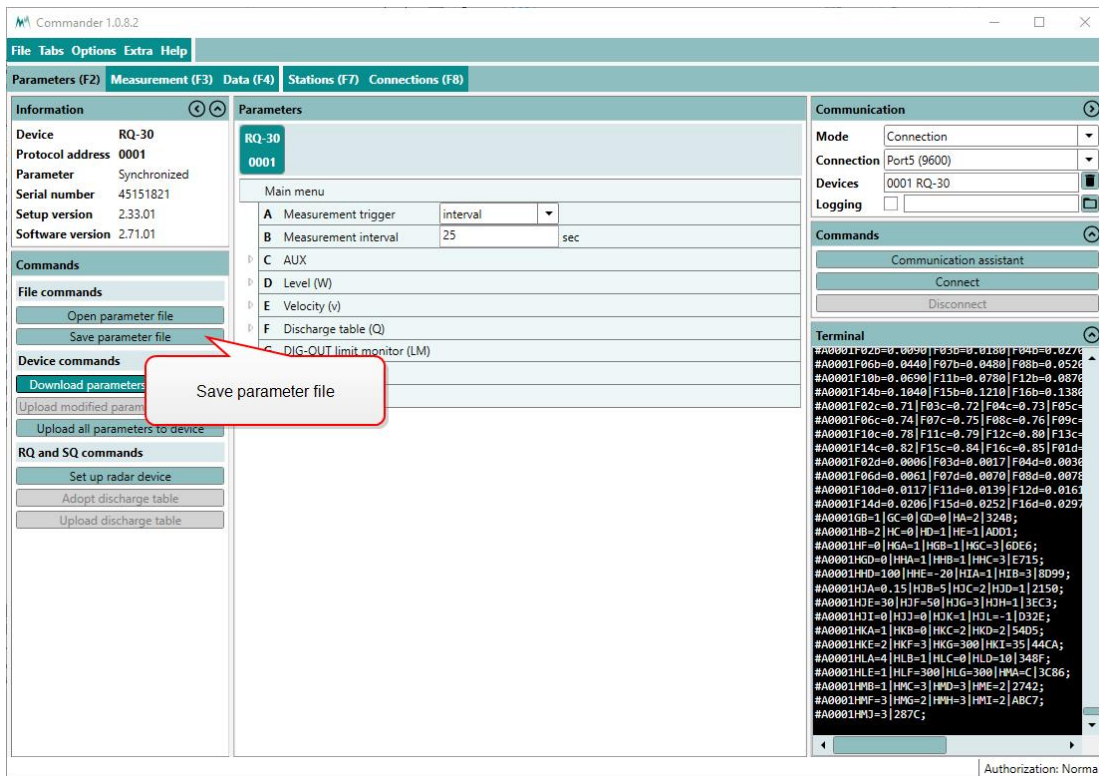

4. Adapt the parameters required for your application. Changed values are displayed with a pink background.

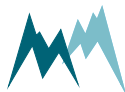
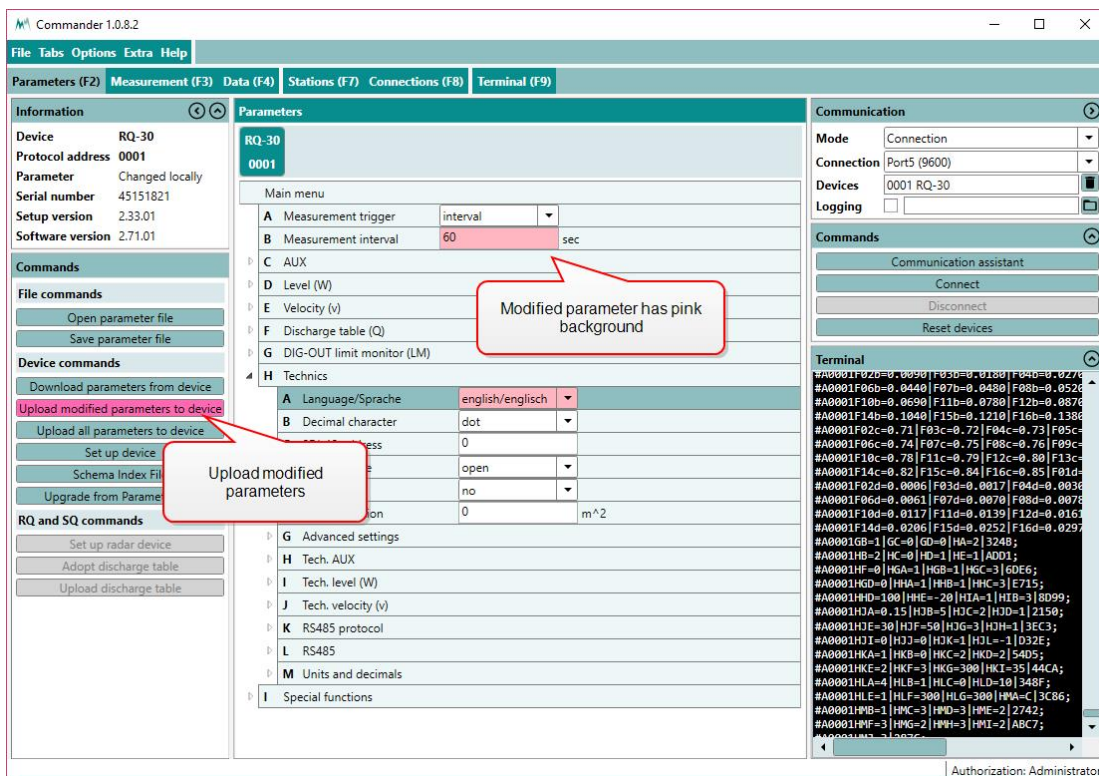

- Send the modifications to the USH-9 by clicking **Upload modified parameters to device**. Upon successful upload the pink backgrounds disappear again.

## 11.3 Configuration with a terminal program

The Commander software ships with an integrated terminal program. However, communication with the USH-9 can be performed with any terminal program.

Follow the steps below to modify the configuration parameters of the USH-9:

- Establish a connection between your PC and the USH-9.
- In the terminal window enter three question marks (???) in quick succession. The main parameter menu is displayed in response.

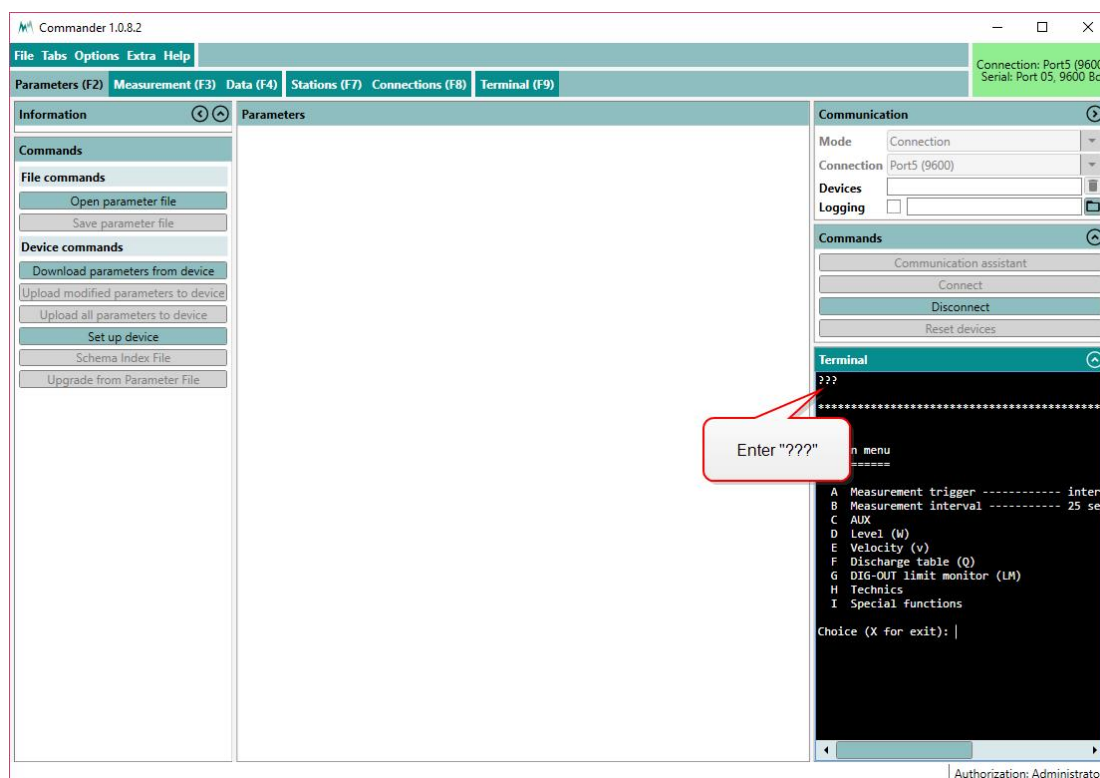

**NOTE** As an unwanted switching into the menu mode has to be avoided the timing of the three question marks ??? is very restrictive and must never be finished with Return/Enter. This is especially important for command line tools, which may automatically send a closing "Carriage return".

3. Read or modify the required parameters: The menu items can be selected by entering the letter assigned to each item. Upon selection a submenu is opened or the selected parameter is displayed with its unit. Changes to values are confirmed with **Return/Enter** or discarded with **Esc**. Menus are closed with **X**. After closing the main menu with **X** the sensor performs an initialization.

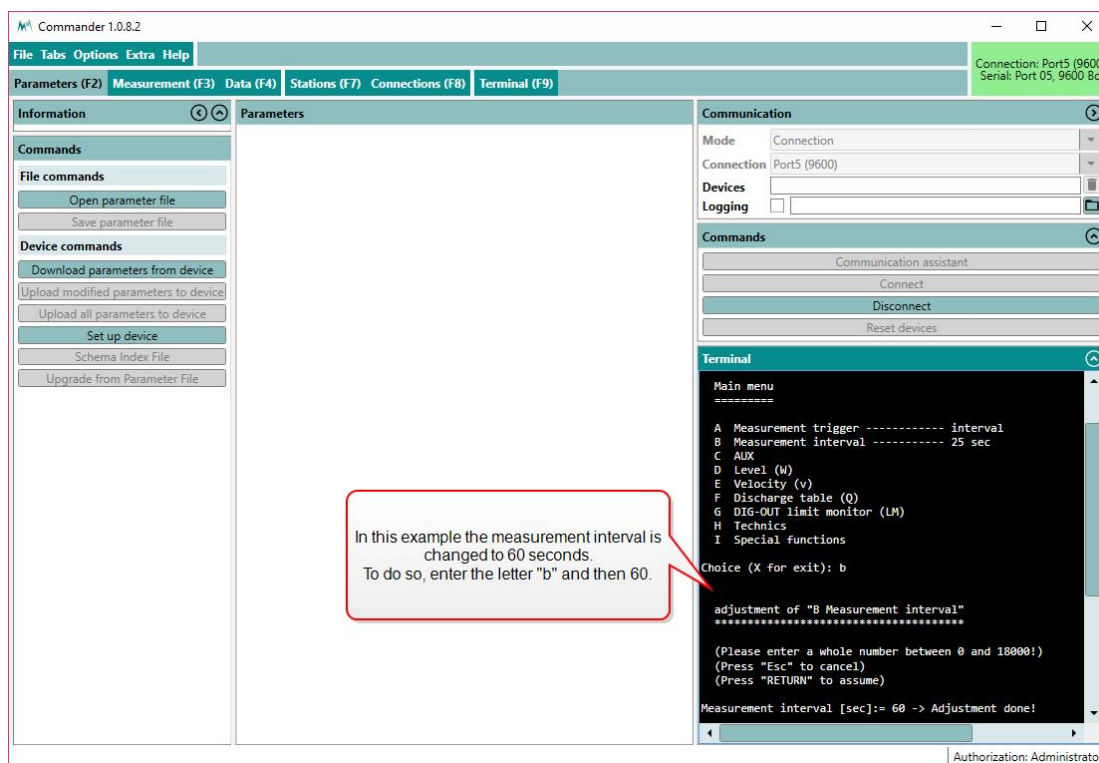

## 11.4 Conflict messages

During configuration via RS-485, the USH-9 may return conflict messages after one or more parameters have been changed and uploaded to the device. An example is shown in [Figure 6](#).



Figure 6 Conflict message



**ATTENTION** If a conflict occurs, invalid settings are replaced automatically with valid values. Verify the values of the conflicting parameters and adapt them if needed!

### 11.4.1 Parameter conflict

A parameter conflict message as listed below is returned if the value of a parameter conflicts with another parameter setting.

Parameter	Comment
Application	If this parameter is set to <i>Snow</i> , the selection of <b>IOUT2, function</b> should be <i>status, snow settling</i> or <i>status, snow</i> .
IOUT2, function	If Application is set to <i>Snow</i> , the selection of <b>IOUT2, function</b> should be <i>status, snow settling</i> or <i>status, snow</i> . If this is not the case, <b>IOUT2, function</b> is changed to <i>off</i> .

Table 2 Parameter conflict messages

### 11.4.2 Setup conflict

A setup conflict message as listed below is returned if a modified setup with conflicting parameters is loaded onto the USH-9.

Conflict code	Parameter	Comment
0001	Max. measurement distance	Must be in the range 1'000 ... 10'000 mm. If the value is outside this range, it is set to the range limit in the selected unit.
0002	Maximum standard deviation	Must be in the range 20 ... 500 mm. If the value is outside this range, it is set to this limit in the selected unit.
0004	RoC, max. at precip. (./h)	This parameter is always set to a value equal or higher than <b>Rate of change, maximum (./h)</b> . If <b>RoC, max. at precip. (./h)</b> and <b>Rate of change, maximum (./h)</b> are equal, the rate of change filter is not dependent on precipitation anymore.

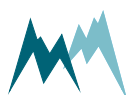

Conflict code	Parameter	Comment
0008	OP, measurement output	If Output protocol (OP) is set to <i>Modbus</i> , this parameter is set to <i>just per command</i> , as Modbus does not support pushing of data.
0010	Measurement Interval	If the value is shorter than Measurement duration + 2 seconds, it is set to Measurement duration + 2 seconds. This setting ensures that the data output is not shifted to the next measurement cycle.

Table 3 Setup conflict messages

## 11.5 General settings

When first setting-up a USH-9 at a measurement site, the parameters described below may need to be adapted.

### 11.5.1 Measurement trigger

Measurements are initiated by one of the options listed in the table below.

The commands to trigger measurements via RS-485 and SDI-12 are described in [Communication](#).

Measured data are either returned directly after the measurement or can be requested by commands via the RS-485 or SDI-12 interface. The format of the returned data can be configured in the sub-menu [Output protocol \(OP\)](#).

ID	Option	Description
1	Interval (default)	Measurements are initiated in a specified interval.
2	TRIG input	Measurements are triggered by the positive edge of a DC-voltage signal applied to the TRIG input (low: 0 ... 0.6 V, high: 2.2 ... 28 V, pulse duration must be $\geq 500$ ms, delay between pulses must be $\geq 500$ ms)
3	SDI-12/RS-485	Measurements are externally triggered by commands via RS-485 or SDI-12 from ,e.g. a data logger.
4	all allowed	Measurement is triggered by all options mentioned above.

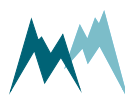

An internal measurement interval can be set for the USH-9. If selected in menu item [Measurement trigger](#), measurements are performed in the defined interval. However, a measurement is always completed before a new one is initiated.

### 11.5.2 Language/Sprache

The menu language.

### 11.5.3 Decimal character

The character used as decimal separator in the values of the settings and in serial data strings.

### 11.5.4 Units and decimals

The units and number of decimal digits. These have to be set prior to all other settings as all values are saved internally in this format. They are set in the parameter menu [Units and decimals](#).



**ATTENTION** If units or decimals are changed, related parameters may need to be adjusted.

### 11.5.5 Output protocol (OP)

The type of the serial output protocol. The following options are available:

ID	Option	Description
1	Sommer (default)	Sommer protocol; data values are returned with an index starting at 1
2	Standard	Standard protocol; data values are returned without an index
3	MODBUS	Modbus protocol

### 11.5.6 OP, information

The main measurement values are always included in the data output string. Additionally, special and analysis values can be included.

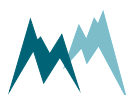

ID	Option	Description
1	main values	Only the main values are returned.
2	& special values (default)	Main values and special values are returned.
3	& analysis values	Main, special and analysis values are returned.

## 11.6 Level/Distance measurements

### 11.6.1 Measurement duration

The duration of a single measurement. During this time the ultrasonic signal is recorded and the distance to the monitored surface calculated. Generally, a measurement duration of 6 s is recommended.

### 11.6.2 Level/distance test

Function to test the level/distance measurement. Initiates a measurement and returns the current distance and level.

### 11.6.3 Adjust level

Function to adjust the level measurement of the USH-9 to the actual level. It first initiates a measurement and then requests the actual level.

### 11.6.4 Distance to zero level

The distance between the sensors lower edge and the ground surface, e.g. lowest point of river bed, ground without snow.

### 11.6.5 Application

Switch to activate the settings for specific applications as listed in the following table:

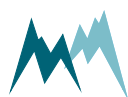

ID	Option	Description
1	snow (default)	Settings for snow applications are active. These settings include precipitation detection and snowfall limits (see <a href="#">Status limits</a> and <a href="#">Advanced settings</a> ). Rate of change filtering (RoC, max. without precip. (./h) and RoC, max. at precip. (./h)) is active.
2	water	Settings for water application are active. Precipitation detection and rate of change filtering (RoC) are deactivated.
3	others	Settings for water and snow applications are inactive. Used for generic level/distance measurements. A constant rate of change filter ( <a href="#">Rate of change, maximum (./h)</a> ) is active.

 **ATTENTION** By default the USH-9 is configured for snow-depth measurements. If the instrument is used for water level monitoring, adapt its configuration as described in [Configuring the USH-9 for water level measurements](#).

### 11.6.6 Moving filter, duration

Every level/distance measurement is stored internally in a buffer for filtering. This setting defines the length of the time window of which the data are stored in the buffer. If the buffer is full, the oldest value is replaced by the most recent one.

The figure below illustrates the default moving filter duration of 180 seconds. While a [Measurement Interval](#) of 90 seconds embraces two measurement values, an interval of 45 seconds includes 4 values.

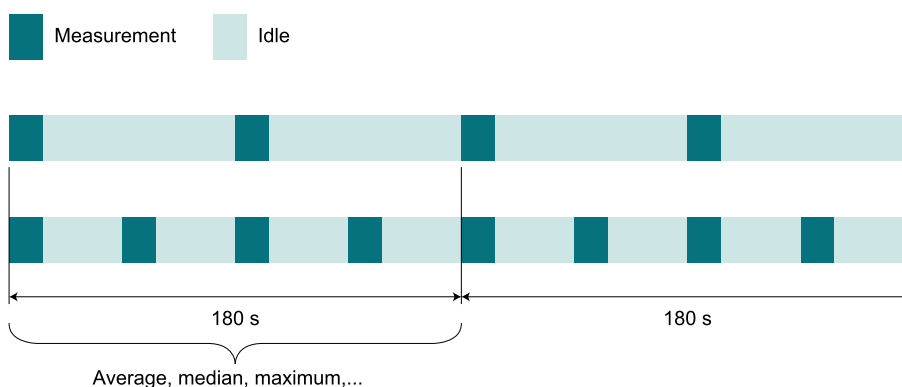

### 11.6.7 Moving filter, type

The level/distance values in the buffer can be filtered by one of the following options:

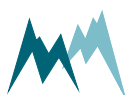



ID	Option	Description
1	average	The mean value of all buffered values is calculated.
2	elim. neg. spikes	To eliminate negative spikes, the mean value is calculated without the 5 lowest buffered values. If the buffer size is smaller than 10, half of the values are eliminated.
3	maximum	The highest value from the buffer is returned.
4	median	The median value of the buffered data is returned.
5	elim. pos. spikes	To eliminate positive spikes, the mean value is calculated without the 5 highest buffered values. If the buffer size is smaller than 10, half of the values are eliminated.
6	elim. all spike (default)	To eliminate positive and negative spikes, the mean value is calculated without the 5 highest and 5 lowest buffered values. If the buffer size is smaller than 15, two third of the values are eliminated.

## 11.7 Configuring the USH-9 for snow measurements

By default the USH-9 is configured for snow applications. This can be checked in the setting [Application](#), which is set to *snow*.

If the USH-9 needs to be re-configured for snow applications, set

1. [Application](#) to *snow*,
2. [Moving filter, duration](#) to 180 seconds, and
3. [Moving filter, type](#) to elim. all spikes.

Settings 2 and 3 may be adapted to values better suited for your application. See [Parameter definitions](#) for more details.



**ATTENTION** Make sure to upload the modified parameters to the USH-9 and test the new settings as described in [How do I test the USH-9 indoors?](#).

## 11.8 Configuring the USH-9 for water level measurements

If the USH-9 is used for water level monitoring, set

1. [Application](#) to *water*,
2. [Moving filter, duration](#) to 0 seconds, and
3. [Moving filter, type](#) to median.

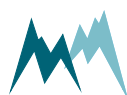

Settings 2 and 3 may be adapted to the flow conditions of your river or channel. See [Parameter definitions](#) or more details.



**ATTENTION** Make sure to upload the modified parameters to the USH-9 and test the new settings as described in [How do I test the USH-9 indoors?](#)

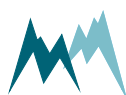

# 12 Communication

## 12.1 Communication protocols

The USH-9 provides the following communication protocols:

- RS-485
- Modbus
- SDI-12

## 12.2 Data output

The measurement values returned by the USH-9 are arranged in a fixed sequence and identified by an index. They are divided into three groups and can be selected in [OP, information](#).

### 12.2.1 Main values

Index	Measurement value	Unit	Description
01	Level	mm	
02	Distance	mm	
03	Temperature	°C	Air temperature
04	Status	-	Status of snow cover, 3-digit number: 100 snowfall 010 snow cover emerges 001 snow-depth limit exceeded Combinations may occur, e.g. 110, signaling that snowfall and an emerging snow cover are detected.

Table 4 Main values



#### NOTE

Status is a logic combination of the parameters listed in menu [Status limits](#).

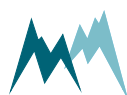



Snowfall is detected if **Snowfall, precipitation limit** is exceeded and the temperature is below **Snowfall, max. temperature**. To suppress this status set **Snowfall, precipitation limit** to  $\leq 0$ .

A snow cover emerges if **Snow settling, strength drop** is exceeded and **Snow settling, maximum level** is not reached. To suppress this status set **Snow settling, maximum level** to a negative value.

## 12.2.2 Special values

Index	Measurement value	Unit	Description
05	Precipitation	-	Dimensionless value representing precipitation type and intensity. Its range is 0 to 1000, where 1000 is the most intensive precipitation that can be expected. The value strongly depends on the type of precipitation: wet snow that falls in large flakes gives high values, cold, small flakes give lower values even though snowfall can be intense. Rain generally gives lower values than snow. The precipitation value is used to optimize the rate of change filter (RoC) that is affected by reflections of precipitation. It cannot substitute a rain gauge.
06	Signal quality	dB	SNR (signal to noise ratio)
07	Std. deviation	mm	Standard deviation of the measured level
08	Supply voltage	V	Power supply voltage

Table 5 Special values

## 12.2.3 Analysis values

Index	Measurement value	Unit	Description
09	Signal focus	dB	Diagnostic variable
10	Signal strength	dB	Diagnostic variable
11	Half-value width	%	Diagnostic variable



Index	Measurement value	Unit	Description
12	Noise ratio 50	%	Diagnostic variable
13	Noise ratio 85	%	Diagnostic variable
14	Echo amp.	-	Diagnostic variable
15	Var. 1	-	Diagnostic variable
16	Var. 2	-	Diagnostic variable
17	Var. 3	-	Diagnostic variable
18	Dist. max. echo	mm	Diagnostic variable
19	Dist. last echo	mm	Diagnostic variable
20	Distance 0 C	mm	Diagnostic variable
21	Case temperature	°C	Diagnostic variable
22	Error code <sup>1</sup>	-	Diagnostic variable

Table 6 Analysis values

## 12.2.4 Exception values

Measurement data may be returned with the following exception values:

Value	Description
9999.998	Initial value: No measurement has been performed yet (position of decimal character is irrelevant).
9999.997	Conversion error: Caused by a technical problem (position of decimal character is irrelevant)
9999999	Positive overflow
-9999999	Negative overflow

Table 7 Exception values

<sup>1</sup>see [Device Errors](#) for details

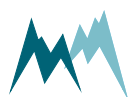

## 12.3 RS-485

### 12.3.1 What is RS-485?

RS-485 is a serial communication method for computers and devices. It is currently a widely used communication interface in data acquisition and control applications where multiple nodes communicate with each other.<sup>1</sup>

### 12.3.2 What can I do with it?

RS-485 communication is primarily used to trigger measurements and read their results. It also permits to change parameters of the USH-9.

### 12.3.3 Configuration

The USH-9 has serial RS-485 communication enabled by default. If the device is integrated into a RS-485 network or connected to a stand-alone data acquisition system, e.g. a data logger, the parameters listed in [RS-485 Protocol](#) may need to be adapted.

#### System key and device number

The system key and device number are used to identify a USH-9 in a bus system. This is essential if multiple devices ( USH-9 and data loggers) are operated within the same system.

##### System key

The system key separates different conceptual bus systems. This may be necessary if the remote radio coverage of two measurement systems overlap. In general, the system key should be set to *00*.

##### Device number

The device number is a unique number that identifies a device in a bus system.

##### OP, measurement output

The serial data output can be triggered in the following ways:

<sup>1</sup><https://www.lammertbies.nl/comm/info/RS-485.html>

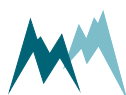

ID	Option	Description
1	just per command	The output is only requested by commands via the RS-485 or SDI-12 interface.
2	after measurement (default)	The serial data output is performed automatically right after each measurement.
3	pos. TRIG slope	The output is triggered by a positive edge of a control signal applied to the trigger input.



**NOTE** If *OP*, measurement output is set to *pos. TRIG slope*, the data are returned with a delay of 200 ms after the trigger has been set. Make sure that your data acquisition system takes account of this lag to ensure that it receives the most recent data.

## Operation modes

The selected combination of measurement trigger and output time determines the following operation modes:

Parameter	Mode		
	Pushing	Polling	Apparent polling
Measurement trigger	internal	TRIG input SDI-12/RS485	TRIG input SDI-12/RS485
OP, measurement output	after measurement	just per command	after measurement

## Waking-up a connected data logger

The USH-9 supports wake-up of a connected data logger that is in standby mode. Generally, this feature is only used in pushing mode and can be set under *OP*, [wake-up sequence](#).

### Sync sequence

The sync sequence is the string `UU~?~?` and is sent directly before a command. It is used to synchronize the receiving UART.

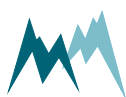

## Prefix

The prefix is an arbitrary character; the USH-9 uses a blank. This character is sent prior to any communication. Then the time of the [OP, prefix holdback](#) is waited and the command is sent afterwards. With this procedure the receiving device has time to wake-up.

## Output protocols

For data output via RS-485 different protocols are available, which can be selected under [Output protocol \(OP\)](#).

### 12.3.4 Data output options

Data are returned in two different formats, selectable in [Output protocol \(OP\)](#):

- [Sommer protocol](#)
- [Standard protocol](#)

### 12.3.5 Sommer protocol

The data string of the Sommer protocol has the following format:

 **EXAMPLE** #M0001G01se01    1461|02    1539|03    25.25|04  
0|3883;

## Header

The header (#M0001G00se) identifies the data by system key, device number and string number.

Parameter	Format	Description
Start character	#	
Identifier	M	M identifies an output string
System key	dd	
Device number	dd	

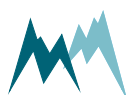



Parameter	Format	Description
Command ID	G	G defines an output string with string number
String number	dd	01 Main values 03 Special values 05 Analysis values 06 Analysis values
Command	se	se identifies automatically sent values

Table 8 Header of the Sommer protocol

## Measurement value

A measurement value (02 1539 |) has a length of 8 digits and is returned together with its index. If the measurement value is a decimal number, one digit is reserved for the decimal character. Values are returned right-aligned, so blanks may occur between index and value.

Parameter	Format	Description
Index	dd	2 numbers
Value	xxxxxxxx	8 character right-aligned
Separator		

Table 9 Values in Sommer protocol

## End sequence

The data string is terminated with a CRC-16 in hex format (3883) followed by an end character and <CR><LF>. The CRC-16 is described in [Sommer CRC-16](#).

Parameter	Format	Description
CRC-16	Hhhh	4-digit hex number
End character	;	
Control characters	<CR><LF>	Carriage return and Line feed

Table 10 End sequence of the Sommer protocol

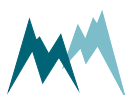

## Example Sommer protocol

### Main values

Main values are returned as in the following example:

 **EXAMPLE** #M0001G01se01 1461|02 1539|03 25.25|04 0|3883;

#M0001G01se	Header with system key 00, device number 01 and string number 01
01 1461	Level
02 1539	Distance
03 25.25	Temperature
04 0	Status
3883 ;	Closing sequence

Table 11 Main values in Sommer protocol

### Special values

Special values are returned as in the following example:

 **EXAMPLE** #M0001G01se01 1461|02 1539|03 25.25|04 0|3883;

#M0001G01se	Header with system key 00, device number 01 and string number 01
01 1461	Level
02 1539	Distance
03 25.25	Temperature
04 0	Status
3883 ;	Closing sequence

Table 12 Special values in Sommer protocol

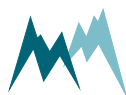

## Analysis values

Analysis values are returned as in the following example:

	<b>EXAMPLE</b>				
#M0001G05se09		33.8 10	43.8 11	34 12	
43.23 13	13.51 14	9 15	-28.6 7E66;		
#M0001G06se16		1 17	2920 18	1565 19	
5578 20	1472 21	25.70 22	0.00 0E53;		

#M0001G05se	Header with system key 00, device number 01 and string number 05 for the analysis values 9 to 15
0 933.8	Signal focus
10 43.8	Signal strength
11 34	Half value width
12 43.23	Noise ratio 50
13 13.51	Noise ratio 85
14 9	Echo amp.
15 -28.6	Var. 1
7E66;	Closing sequence
#M0001G06se	Header with system key 00, device number 01 and string number 06 for the analysis values 16 to 22
16 1	Var. 2
17 2920	Var. 3
18 1565	Dist. max. echo
19 5578	Dist. last echo
20 1472	Distance 0 C
21 25.70	Case temperature
22 0.00	Error code
0E53;	Closing sequence

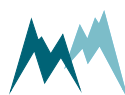

Table 13 Analysis values in Sommer protocol

### 12.3.6 Standard protocol

The data string of the Standard protocol has the following format:

 **EXAMPLE** M\_0001      1461      1359      25.38      0

#### Header

The header (M\_0001) identifies the data by system key and device number.

Parameter	Format	Description
Identifier	X_	M_ Measurement values S_ Special values V_ Analysis values
System key	Dd	
Device number	Dd	

Table 14 Header of the Standard protocol

#### Measurement values

Measurement values are returned in sequence and are separated by a blank. A measurement value has a length of 8 digits. If the measurement value is a decimal number, one digit is reserved for the decimal character. Values are returned right-aligned, so additional blanks may be returned between values.

Parameter	Format	Description
Separator	[blank]	blank
Value	xxxxxxxx	8 character right-aligned

Table 15 Values in Standard protocol

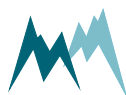

## End sequence

The data string is terminated with <CR><LF>.

## Example Standard protocol

### Main values

Main values are returned as in the following example:

 <b>EXAMPLE</b> M_0001      1461      1359      25.38      0	
<b>M_0001</b>	Header with identifier for measurement values
<b>1461</b>	Level
<b>1359</b>	Distance
<b>25.38</b>	Temperature
<b>0</b>	Status

Table 16 Main values in Standard protocol

### Special values

Special values are returned as in the following example:



 <b>EXAMPLE</b> S_0001      1004      46.5      2      11.69	
<b>S_0001</b>	Header with identifier for measurement values
<b>1004</b>	Precipitation
<b>46.5</b>	Signal quality
<b>2</b>	Std. deviation
<b>11.69</b>	Supply voltage

Table 17 Special values in Standard protocol

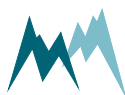

## Analysis values

Analysis values are returned as in the following example:

	<b>EXAMPLE</b>	v_0001	39.2	43.8	30	42.85
	13.56	9	-25.1	1	3023	1563
	5543	1473	25.50	0.00		

v_0001	Header with identifier for analysis values
39.2	Signal focus
43.8	Signal strength
30	Half value width
42.85	Noise ratio 50
13.56	Noise ratio 85
9	Echo amp.
-25.1	Var. 1
1	Var. 2
3023	Var. 3
1563	Dist. Max. echo
5543	Dist. Last echo
1473	Distance 0 C
25.50	Case temperature
0.00	Error code

Table 18 Analysis values in Standard protocol

### 12.3.7 Sommer old protocol

The data string of the Sommer old protocol has the following format:

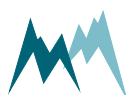



**EXAMPLE** #M0001G00se00 - 17.4|01 0.535|02 0.000|03 -  
1.89|04 0.0|05 0|B11D;

This protocol is identical with the Sommer protocol except that the index of the measurement values starts at 0 instead of 1.

This protocol has been implemented for compatibility reasons: When a Sommer device with firmware < 2.0 is updated to version 2.x the protocol is automatically set to Sommer old. Thus, the setup of a connected data logger does not have to be adjusted.

### 12.3.8 RS-485 commands

#### Command structure

The structure of serial commands and answers (#W0001\$mt|BE85;) is described in the following table:

Parameter	Format	Description
Start character	#	
Identifier	X	<p>W USH-9 returns a confirmation on receipt. This command type demands a closing sequence with a valid CRC-16.</p> <p>S USH-9 does not acknowledge the receipt of the command. This command type demands no closing sequence and therefore no CRC-16.</p> <p>R USH-9 returns the requested measurement value or parameter. This command type demands a closing sequence with a valid CRC-16.</p> <p>T Write a volatile setting and receive a confirmation</p> <p>A Answer of device to read or write command</p>
System key	dd	
Device number	dd	
Command	xxx	See <a href="#">RS-485 commands</a>

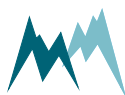

Parameter	Format	Description
Separator		
CRC-16	hhhh	4-digit hex number
End character	;	

Table 19 Structure of Sommer bus commands and answers

## Commands

The following commands can be used with the USH-9:

Command	Description
\$mt	Trigger a measurement
\$pt	Return measurement values
XX	Read a parameter with identifier XX
XX=xxxx	Write a parameter with identifier XX and the value xxx

Table 20 List of Sommer bus commands

### Trigger a measurement

The command \$mt triggers a complete measurement sequence as in the following example:

 **EXAMPLE** #W0001\$mt|BE85; Answer: #A0001ok\$mt|4FA9;

### Read a parameter value

Read measurement interval (in the example below the menu item B):

 **EXAMPLE** #R0001B|228E; Answer: #A0001B=300|F8B3;

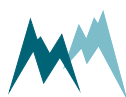



## Request a complete data string

The command `$pt` requests a data string as in the following example:



**EXAMPLE** `#S0001$pt|` Answer: none

The data string is returned as soon as the USH-9 has processed the command.

## Request a single measurement value

The reading command `R` together with the index of the requested measurement returns a single measurement value. In the following example the measurement value with index `01` (in this example a water level) is requested:



**EXAMPLE**

`#R0001_010cv|EA62;`

Answer: `#A0001ok_010cv1461 |07EB;`

### 12.3.9 Sommer CRC-16

The CRC-16 (cyclic redundancy check) used in data transmission of Sommer devices is based on the ZMODEM protocol. When data are exchanged between two devices the receiving device calculates the CRC-value. This value is compared to the CRC value sent by the other device to check if the data were transmitted correctly. Please refer to technical literature or contact Sommer for calculation of CRC-16 values.

You can [here](#) calculate the CRC of a command online .

If you need to compute CRCs automatically, you can implement the following script in your data logger or controller software:

Computation CRC-16 in C/C++

```
1 | crc16 = crc16tab[(unsigned char)(crc16>>8)] ^ (crc16<<8) ^ (unsigned int)(c);
```

The `crc16tab` array is listed in [CRC-16 array](#).



## 12.4 SDI-12

### 12.4.1 What is SDI-12?

SDI-12 (Serial Data Interface at 1200 Baud) is a serial data communication standard for interfacing multiple sensors with a single data recorder. For a detailed description on SDI-12 communication please refer to [www.sdi-12.org](http://www.sdi-12.org).

### 12.4.2 What can I do with it?

The USH-9 listens to standard SDI-12 commands as listed in the SDI-12 specifications of version 1.3, e.g., to trigger a measurement or retrieve measurement results. Additionally, a set of extended SDI-12 commands is implemented in all SOMMER sensors for instrument configuration.

### 12.4.3 Configuration

The USH-9 has SDI-12 communication enabled by default. When setting up a SDI-12 network take the following considerations into account:

- Each device in the SDI-12 network must have a unique address, e.g. data logger address *0*, USH-9 address *1*.
- If the USH-9 operates in polling mode (**Measurement trigger** set to *SDI-12/RS-485*), measurements are triggered by **M!** commands and data are retrieved by **D!** commands.
- If the USH-9 operates in pushing mode (**Measurement trigger** set to *interval*), data are retrieved by the **R!** commands.
- When multiple sensors are connected to the same network, data acquisition should be done in sequence, i.e., data should have been received from the first sensor before triggering the measurement of the second sensor.
- Most data loggers control the timing of messages (marking and spacing) automatically. If this is not the case, please refer to [www.sdi-12.org](http://www.sdi-12.org).

### 12.4.4 Data structure

The answer from the SDI-12 device is a string containing the sensor address, the requested data and a terminating carriage return/line feed.

In a string containing measurement data, the measurements are returned in the same order as listed by the index in [Data output](#).

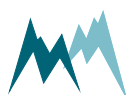

**EXAMPLE**

```
0+2591+706+25.53+62<CR><LF>
```

Value	Content
0	Sensor address
2591	Measurement with index 01
706	Measurement with index 02
25.53	Measurement with index 03
62	Measurement with index 04

If a device returns more than 9 measurement values, or if the values are returned in groups (see also [Request results](#)) the measurement index increments in the next group.

**EXAMPLE**

```
0D0! Answer: 0+2591+706+25.53+62<CR><LF>
```

```
0D0! Answer: 0+56.2+125+12.32<CR><LF>
```

Value	Content
0	Sensor address
2591	Measurement with index 01
706	Measurement with index 02
25.53	Measurement with index 03
62	Measurement with index 04
0	Sensor address
56.2	Measurement with index 05
125	Measurement with index 06
12.32	Measurement with index 07

## 12.4.5 SDI-12 commands

The following tasks can be performed with standard and extended SDI-12 commands.

Extended SDI-12 commands are non-standard commands implemented by SOMMER to enable device configuration via SDI-12.

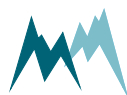



**NOTE** After any changes, the settings have to be adopted with the command `aXW_ts|!`, with `a` the sensor address.

## Command structure

A standard SDI-12 command starts with the sensor address and ends with an exclamation mark, e.g., `0M!` to trigger a measurement.

Configuration commands contain additional information; see the sections below for details.

## Identify device

The identification of a SDI-12 device is requested with the command `aI!`, with `a` the sensor address.



### EXAMPLE

`0I! Answer 013Sommer USH 140r90 USH-9 <CR><LF>`

The answer contains the following information:

0	SDI-12 address
1	SDI-12 version prior to the point
3	SDI-12 version after the point
Sommer	Description of the company (6 characters and 2 blanks)
USH	Description of the firmware (5 characters and 2 blanks)
140r90	Firmware version (6 characters and 2 blanks)
USH-9	Device designation (max. 13 characters)

## Acquire measurements

To acquire a measurement from a sensor, two individual SDI-12 commands – trigger a measurement and request measurement values – need to be sent.



### EXAMPLE

`0M! Answer: 00084<CR><LF> and 0<CR><LF> after 8 seconds`

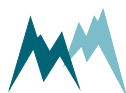



0D0! Answer: 0+2591+706+25.53+0<CR><LF>

The first values in the response to the aDn! command is the sensor address.

## Trigger measurement

The command aM! with sensor address a triggers a measurement as in the example below.

The response states the measurement duration and the number of measurement values (see example below). After completion of the measurement, the device will return an additional a<CR><LF>, with a the sensor address.



### EXAMPLE

0M! Answer: 00084<CR><LF> and 0<CR><LF> after 8 seconds

The answer contains the following information:

- 0 SDI-12 address
- 008 Duration of the measurement in seconds
- 4 Number of measurement values

## Request results

After each measurement, results are requested with the command aDn!, with a the sensor address and n the index of the returned data string.



EXAMPLE 0D0! Answer: 0+2591+706+25.53+0<CR><LF>

The leading 0 of the response is the sensor address.

Generally, the command aD0! is sufficient to request up to 9 measurement values. If more than 9 values need to be read, or if the values are returned in groups, the commands aD1!, aD2!,... may need to be issued after aD0!. For example, if a measurement returns 8 values in two groups of 4, the commands aD0! and aD1! need to be issued to receive all values.

## Acquire continuous measurements

If the SDI-12 device is operating in continuous measurement mode (not polled by SDI-12), the command aR0! will request and return the current reading of the sensor. The values within the data

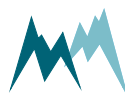

string follow the order listed in the measurement table. The first values in the response to the `aRn!` command is the sensor address.



#### EXAMPLE

`0R0!` Answer: `0+2591+706+25.53+0<CR><LF>`

If more than 9 values need to be read, or if the values are returned in groups, the commands `aR1!`, `aR2!`,... may need to be issued after `aR0!`. For example, if a measurement returns 8 values in two groups of 4, the commands `aR0!` and `aR1!` need to be issued to receive all values.

## Configure parameter

The configuration parameters of a SOMMER sensor are read with the command `aXRpp!` and written with the command `aXWpp=vvv!`, with `a` the sensor address, `pp` the parameter identifier and `vvv` the value of the parameter.

## Read and write a parameter



#### EXAMPLE

Reading of measurement interval (in this example menu item B)

`0XRB|!` Answer: `0B=300|<CR><LF>`

Setting of measurement interval to 60 s (in this example menu item B)

`0XWB=60|!` Answer: `0B=60|<CR><LF>`

## Read and write a selector-parameter

Changing the measurement trigger (in the following example menu item A) from *interval* to *SDI-12/RS485*:



#### EXAMPLE

`0XRA|!` Answer: `0A=1|<CR><LF>`

`0XWA=3|!` Answer: `0A=3|<CR><LF>`

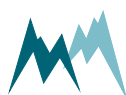

## Read and write a parameters of a table

Some SOMMER sensors are equipped with multiple transducers and their settings are listed in a table (see example below). A value within such a table is addressed by its row-index (01, 02 ...) and column-index (A, B ...). A corresponding SDI-command has the following format:



### EXAMPLE

In this example of a snow scale the value in row 01 and column B of the parameter D-D-E is changed to -1.4.

0XWDDE01B=-1.4|! Answer: 0DDE01b=-1.4|<CR><LF>

	Identifier	offset zero kg	gain	zero default kg	gain default
01	Load Cell 1	-1.4	0,997787	0,000	0,997787
02	Load Cell 2	0,000	0,997787	0,000	0,997787
03	Load Cell 3	0,000	0,997787	0,000	0,997787
04	Load Cell 4	0,000	0,997787	0,000	0,997787

## Adopt settings

Some settings need to be adopted with the command `aXW_ts|!`, with `a` the sensor address. It is recommended to issue `aXW_ts|!` after each configuration change.

## 12.5 Modbus

### 12.5.1 What is Modbus?

Modbus is a serial communication protocol used for transmitting information over serial lines between electronic devices. The device requesting the information is called the Modbus Master and the devices supplying information are Modbus Slaves. In a standard Modbus network, there is one Master and up to 247 Slaves, each with a unique Slave Address from 1 to 247. The Master can also write information to Slaves.

Modbus has become a standard communication protocol in industry, and is now the most commonly available means of connecting industrial electronic devices. It is often used to connect a supervisory computer with a remote terminal unit (RTU) in supervisory control and data acquisition (SCADA)

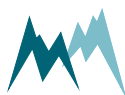

systems. Versions of the Modbus protocol exist for serial lines (Modbus RTU and Modbus ASCII) and for Ethernet (Modbus TCP).<sup>1</sup>

## 12.5.2 What can I do with it?

Modbus-communication with USH-9 allows reading of measurement values and device information by a Modbus master. Additionally, the basic RS-485 port settings can be written to the USH-9.

## 12.5.3 Wiring

For Modbus communication the USH-9 is wired according to the table below.

Modbus	Connector MAIN	Connection wire	Description
Common	Pin 1	White	GND
D1 - B/B	Pin 4	Yellow	RS-485 A
D0 - A/A	Pin 5	Grey	RS-485 B

Table 21 Modbus wiring



**NOTE** If the USH-9 is operated with multiple Modbus devices within the same network, termination resistors may be required. Please contact Sommer Messtechnik for details.

## 12.5.4 Configuration

Follow the instructions below to change the communication of a Sommer-device (in this example a RG-30) to Modbus:

1. Connect the USB to RS-485 converter to the data cable of the Sommer-device and a USB port on your PC.
2. Connect the sensor to a power supply with the specified rating.
3. Start the Commander software on your PC.
4. Establish a connection to the Sommer-device.
5. Download the sensor's parameters in the **Parameters (F2)** tab and save the parameter list on your PC.

<sup>1</sup><http://www.simplymodbus.ca/FAQ.htm>

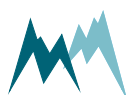



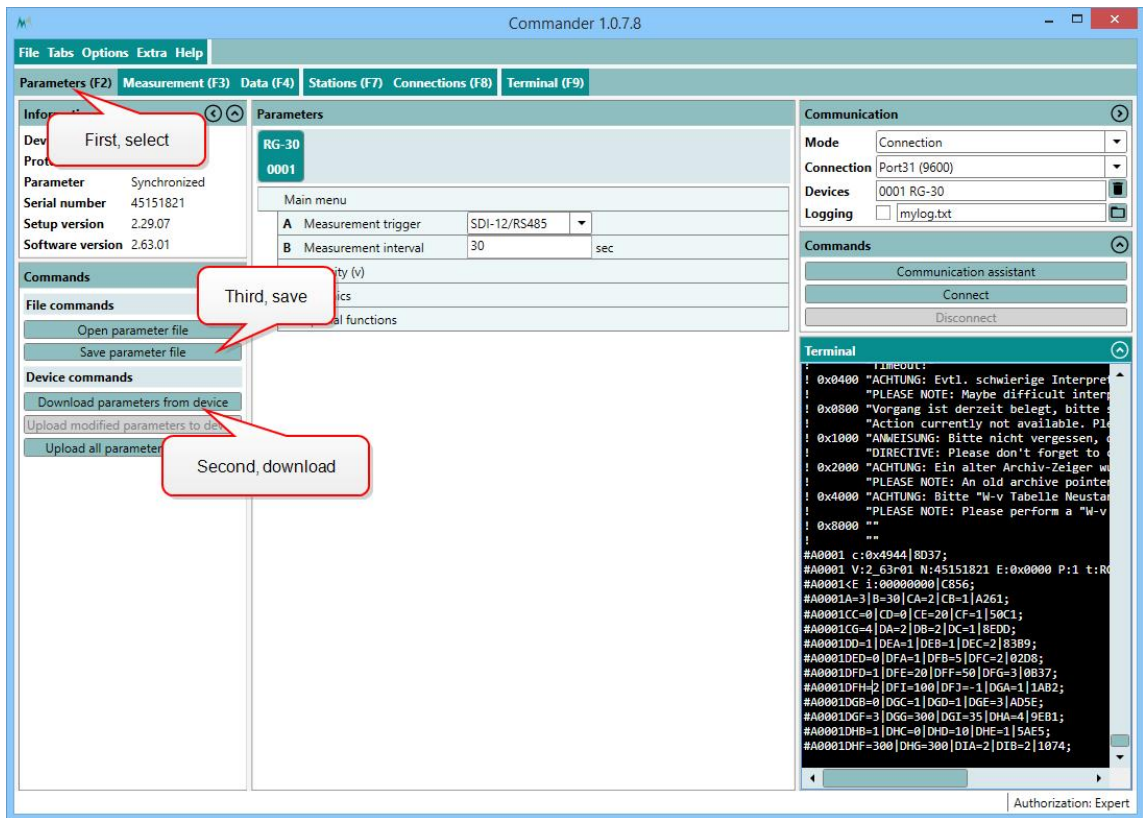

- In the parameter list navigate to Technics and open the menus **RS-485 protocol** and **RS485** and take a screenshot of the associated parameters. This and the previous step are helpful if you need to switch back to the standard communication mode at a later time.



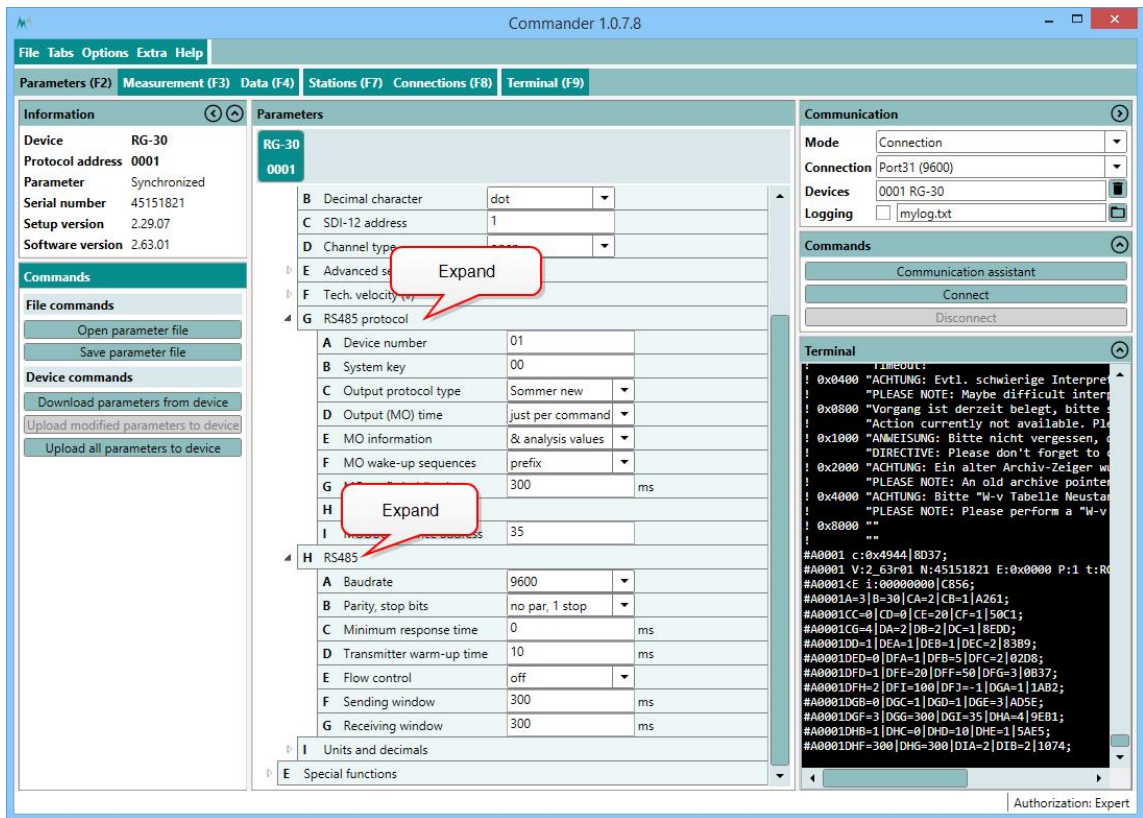

7. Set **Measurement trigger** to one of the following options:
  - A. *Interval*, if measurements are triggered internally by the device.
  - B. *SDI-12/RS-485*, if measurements are triggered by SDI-12.
  - C. *TRIG input*, if measurements are triggered by a trigger input.
  - D. *all allowed*, if measurements are triggered by one of the previous options.



**NOTE** Modbus cannot trigger measurements! Make sure to use the trigger option suitable for your application!

8. Verify that the connection to the Sommer-device is active and click into the Terminal window. Type `???` to enter the sensor-menu.

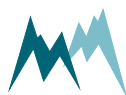

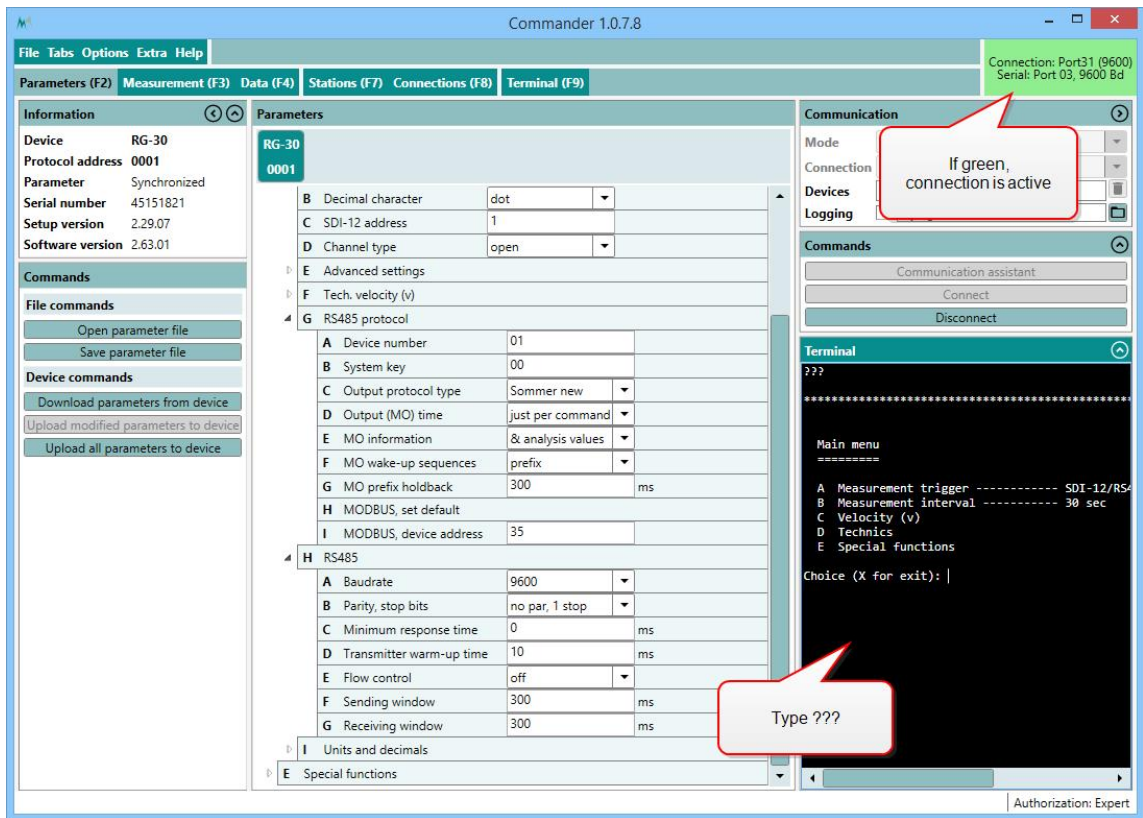

- Navigate to *RS485 protocol* and select *MODBUS, set default...* Please note, that the index-letters might be different for your Sommer-device!

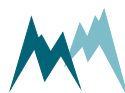

```

Terminal

Main menu
=====

A Measurement trigger ----- SDI-12/RS485
B Measurement interval ----- 30 sec
C Velocity (v)
D Technics
E Special functions

Choice (X for exit): d

Technics
=====

A Language/Sprache ----- english/englisch
B Decimal character ----- dot
C SDI-12 address ----- 1
D Channel type ----- open
E Advanced settings
F Tech. velocity (v)
G RS485 protocol
H RS485
I Units and decimals

Choice (X for exit): g

RS485 protocol
=====

A Device number
B System key --
C Output protocol
D Output (MO) t
E MO information
F MO wake-up se
G MO prefix holdback ----- 100 ms
H MODBUS, set default...
I MODBUS, device address ----- 35

Choice (X for exit): |

```

Enter the letter of 'MODBUS, set default ...'

10. Acknowledge the safety-note.

```

Start up testmode: 0x09

MODBUS, set default
AAAAAAAAAAAAAAAAAAAA

PLEASE NOTE: This process changes to 19200 baud, even parity, ...
DIRECTIVE: Please don't forget to change the serial counterpart too!

Are you sure?

(Press "RETURN" to assume)
(Press "Esc" to cancel)

```

Press Enter

11. After completion the following message will be displayed:

```

=> Testmode finished!
=> DIRECTIVE: Please don't forget to change the serial counterpart too!

```

12. Enter X until you get back to the main menu. The Sommer-device is now restarted and available for Modbus-communication. As the connection-parameters have been changed to Modbus, the connection to the sensor is lost. Press Disconnect for completion.

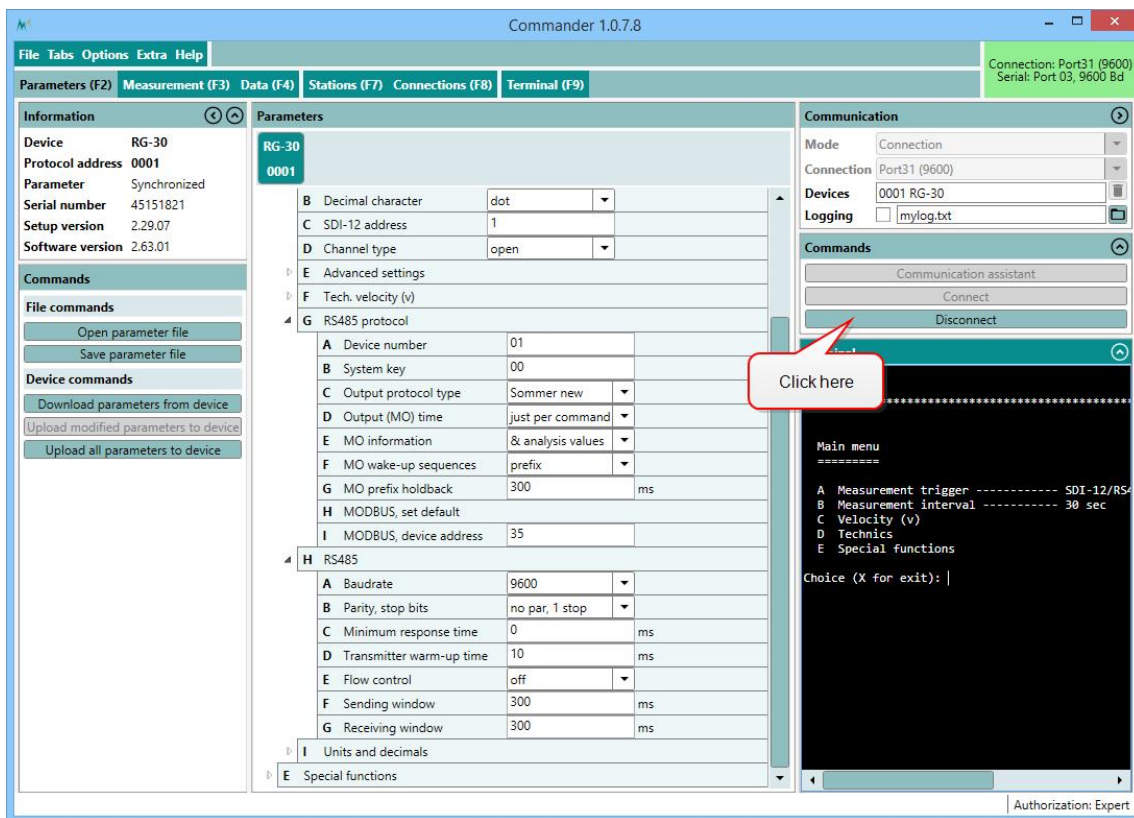

**NOTE**

By switching communication to Modbus with **MODBUS, set default** the following parameters are changed:

Parameter	Modbus setting
OP, measurement output	just per command
Output protocol (OP)	Modbus
MODBUS, device address	35
Sleep mode	Modbus, slow
Parity, stop bits	even par, 1 stop
Baud rate	19200
Flow control	off
Transmitter warm-up time	10 ms
Minimum response time	30 ms

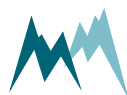

## 12.5.5 Modbus commands and registers

### Read input registers

Input registers contain measurement values. The content of these registers is updated after each measurement.

	Register address	Variable	Unit / value	Bytes	Format
Tes value	0	Hardcoded test value	2.7519...	4	float
Main values	2	Level	mm <sup>1</sup>	4	float
	4	Distance	mm <sup>1</sup>		
	6	Temperature	°C/F		
	8	Status	-		
Special values	10	Precipitation	-	4	float
	12	Signal quality	dB		
	14	Std. deviation	mm <sup>1</sup>		
	16	Supply voltage	V		

<sup>1</sup>Unit according to submenu .

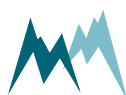

	Register address	Variable	Unit / value	Bytes	Format
Analysis values	18	Signal focus	dB	4	float
	20	Signal strength	dB		
	22	Half-value width	%		
	24	Noise ratio 50	%		
	26	Noise ratio 85	%		
	28	Echo amp.	-		
	30	Var. 1	-		
	32	Var. 2	-		
	34	Var. 3	-		
	36	Dist. max. echo	mm		
	38	Dist. last echo	mm		
	40	Distance 0 C	mm		
	42	Case temperature	°C/F		
	44	Error code	-		
Device info	65533	Device type and configuration	320X	2	unsigned int
	65534	Software version	XYZZ	2	unsigned int
	65535	Modbus implementation version	10100	2	unsigned int

Table 22 Input registers

## Read and write holding registers

Holding registers are mainly used to configure the Modbus adapter communication. Configuration settings are read with function 03 (read holding registers) and written with function 06 (write single registers).



**NOTE** Restart the Modbus adapter after changing the configuration!

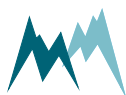

	Register address	Variable	Range	Bytes	Format
Config values	0	Modbus default <sup>1</sup>	0 - 1...read 1...write	2	unsigned int
	1	Modbus device address	1 to 247		
	2	RS-485 baud rate	1...1200 baud 2...2400 baud 3...4800 baud 4...9600 baud 5...19200 baud 6...38400 baud 7...57600 baud 8...115200 baud		
	3	RS-485 parity/ stop bits	1...no parity, 1 stop bit 2...no parity, 2 stop bits 3...even parity, 1 stop bit 4...odd parity, 1 stop bit		

Table 23 Holding registers

**Report slave ID**

The Modbus function 17 (report slave ID, read only) can be used to read basic information of the USH-9. The following example shows the response of function 17 of a RG-30 sensor, which is received in hex-format:

 **EXAMPLE** 23 11 26 53 FF 27 74 20 53 6F 6D 6D 65 72 20  
20 52 47 2D 33 30 20 20 20 32 5F 37 31 72 30 31 20 34  
35 31 35 31 38 32 31 00 BB D4

<sup>1</sup>Writing "1" sets the Modbus default settings.

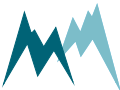



			Example	
	Content	Length (Bytes)	HEX-value	Decimal, ASCII
PDU* response	Slave address	1	23	35
	Function code	1	11	17
	Number of bytes (excl. slave-address, function code, NUL and CRC)	1	26	38
	Slave ID	1	53	"S"
	Run status (0=inactive; FF=active)	1	FF	255
	Modbus implementation version	2	27 74	10100
	Separator	1	20	" "
	Vendor string	7	53 6F 6D 6D 65 72 20	"Sommer "
	Separator	1	20	" "
	Device configuration	7	52 47 2D 33 30 20 20	"RG-30 "
	Separator	1	20	" "
	Software version	7	32 5F 37 31 72 30 31	2_71r01
	Separator	1	20	" "
	Serial number	8	34 35 31 35 31 38 32 31	45151821
	NUL	1	00	
	CRC	2	BB D4	

\*Protocol Data Unit

Table 24 Slave ID

## 12.5.6 Reactivate Sommer protocol

Follow the instructions below to change the data output back to Sommer-protocol:

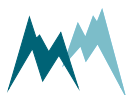

1. Open the **Connections (F8)** tab and click **New connection**.

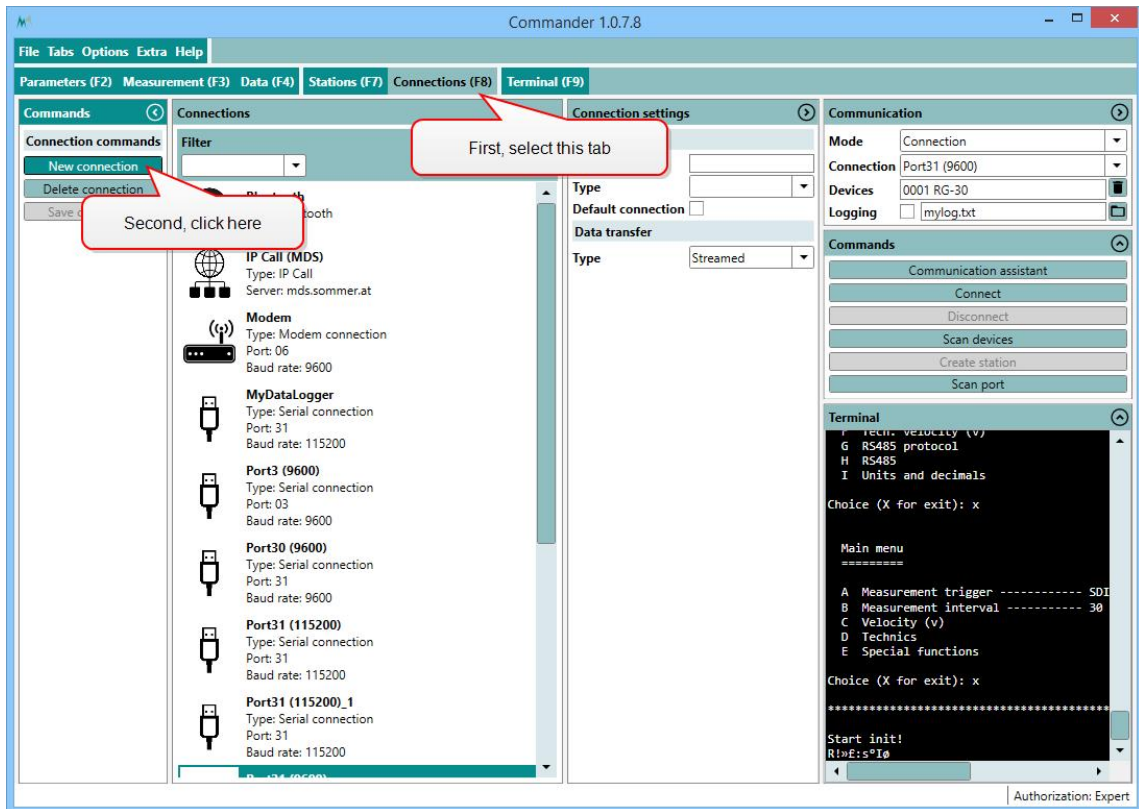

2. Enter the **Name** of the new connection. We recommend to use a meaningful name for later recognition, e.g. Modbus31 (19200) to indicate port 31 and Baud-rate 19200. Select the **Type** **Serial connection** and choose the **Port** your sensor is connected to, set the **Baud-rate** to **19200** and the **Parity/stop bits** to **Even par., 1 stop bit**.

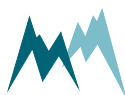

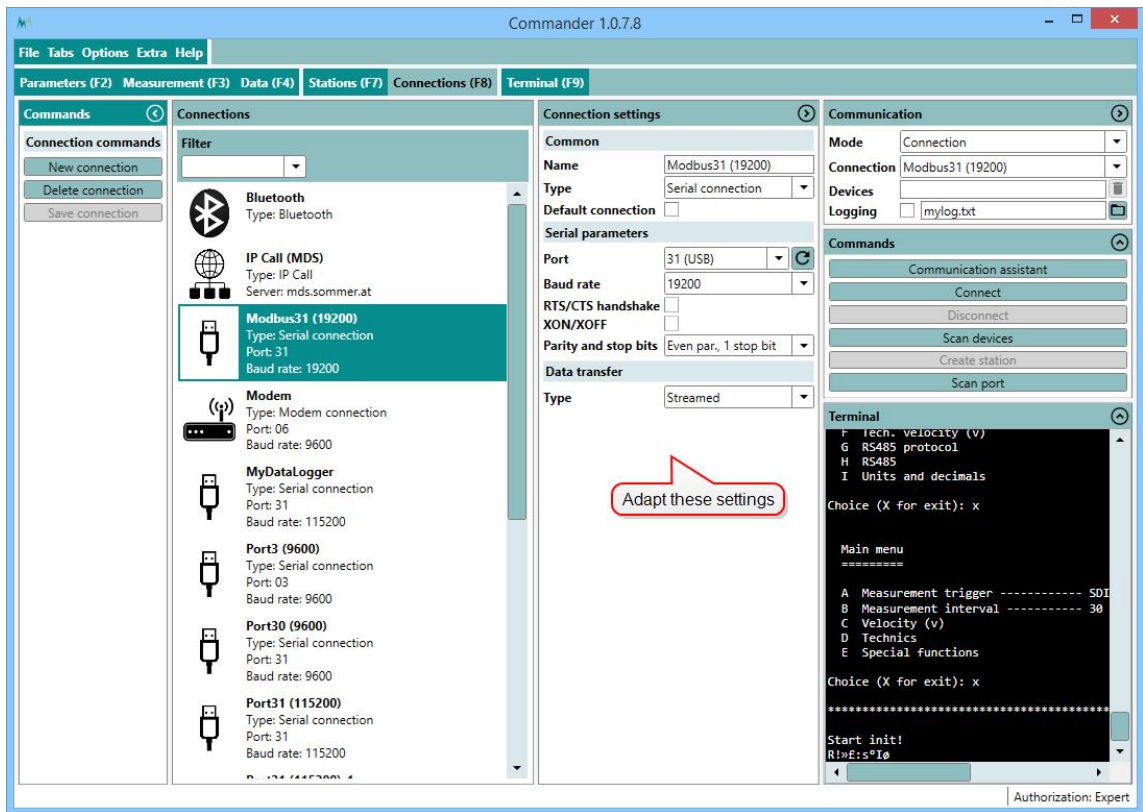

3. Click **Save connection**.
4. In the **Communication** window select **Mode Connection** and choose the **Connection** you have created. Then click **Connect**.



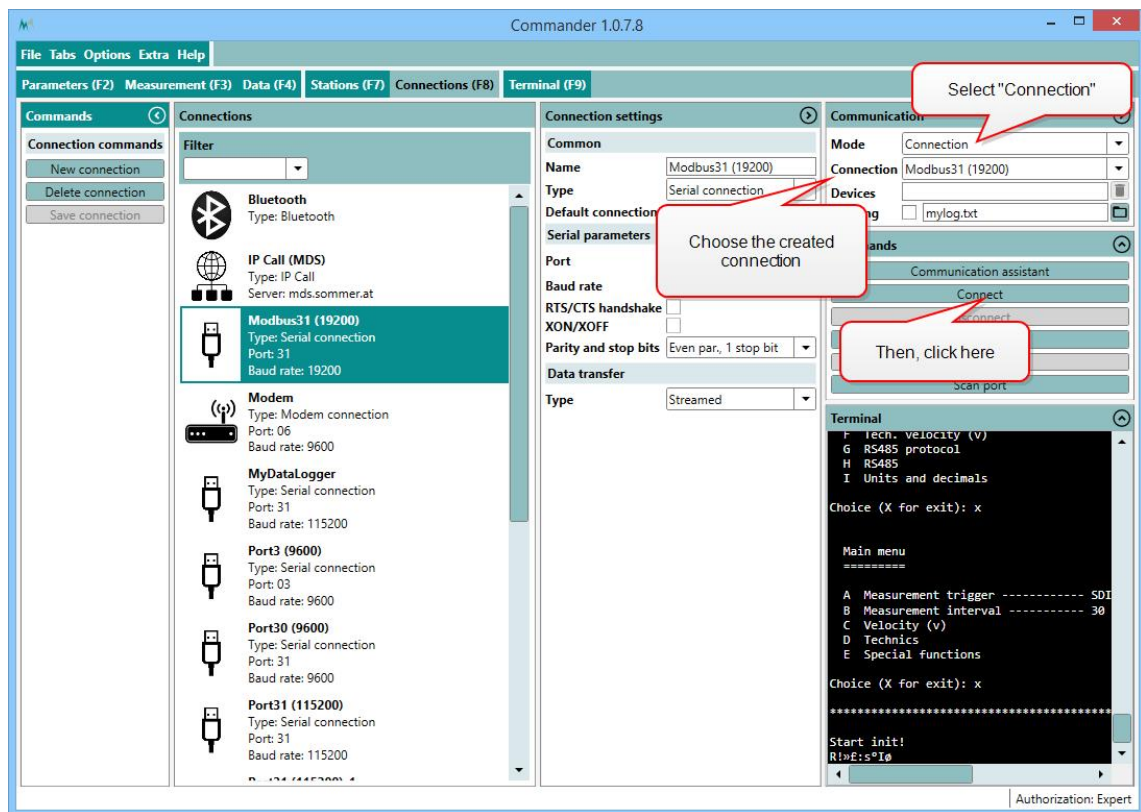

- Download the parameters and save the parameter file as described in [Configuration](#).



**TIP** Save the parameter file for future use and to document configuration changes!

- Now, two options are available to revert communication back to the Sommer-protocol:
  - If a parameter file is available that has the Sommer-protocol enabled, the file can be loaded by clicking [Open parameter file](#), selecting the respective file and uploading the parameters to the device by clicking [Upload all parameters to device](#).

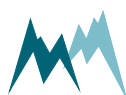

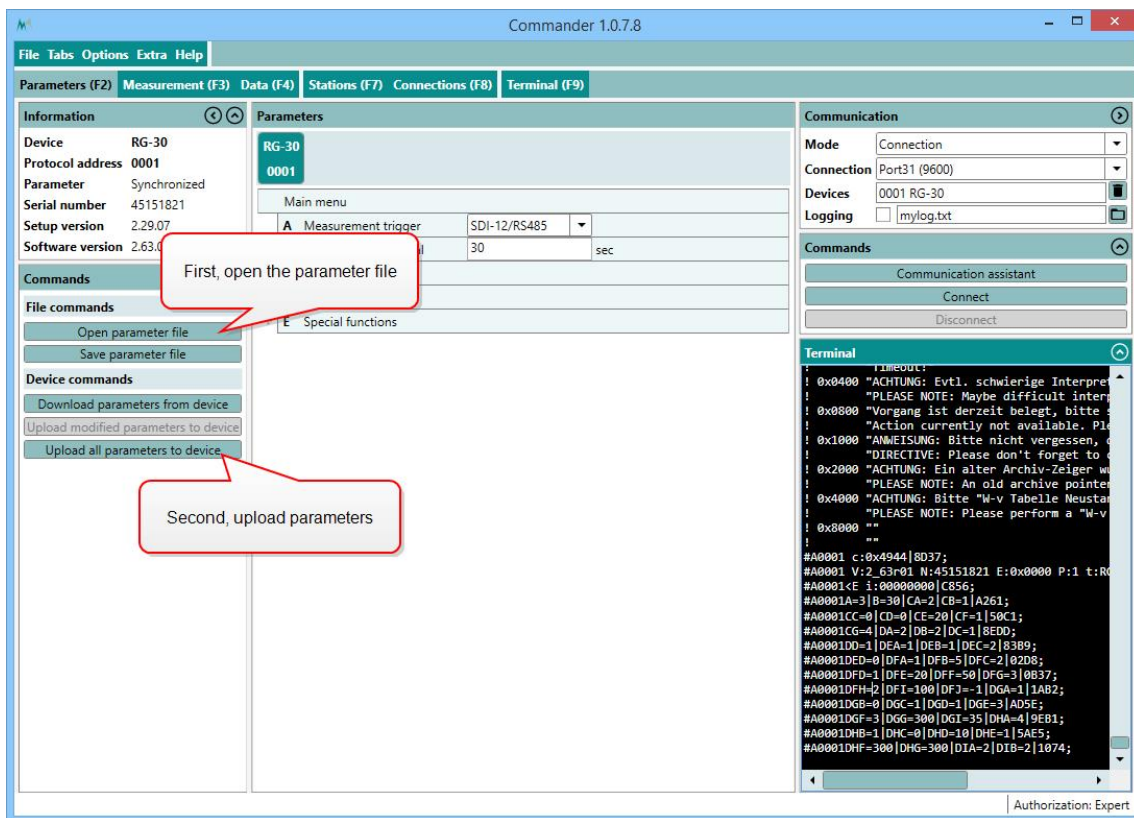

B. If no parameter file is available, the device has to be reset to its default configuration:

1. Click into the **Terminal** window and type ??? to enter the sensor-menu.

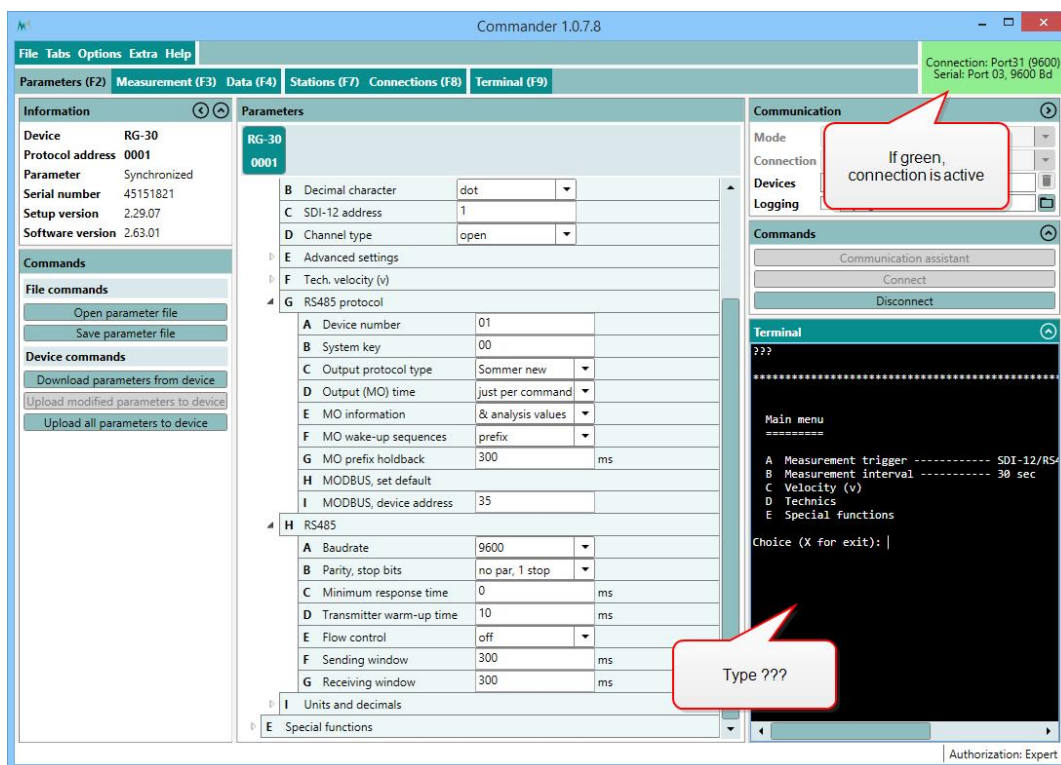

2. Navigate to **Special functions** and select **Set factory default...**

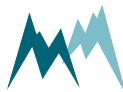

- Acknowledge the safety-note.

```

Start up testmode: 0x07

Set factory default
^^^^^^^^^^^^^^^^^^^^

PLEASE NOTE: Please save all parameters before!
PLEASE NOTE: All user settings will be lost!
Are you sure?

(Press "RETURN" to assume)
(Press "Esc" to cancel)

=> Testmode finished!

```

- Enter `X` until you get back to the main menu. The Sommer-sensor is now restarted and available in its initial configuration. As the connection-parameters have been changed to the default settings, the connection to the sensor is lost. Press **Disconnect** for completion.
- Establish the original connection to the Sommer-sensor as described in [Configuration](#).
- Download the sensor's parameters in the **Parameters (F2)** tab, adapt the required parameters, or upload your originally saved parameter file to the USH-9.

### 12.5.7 PLC integration

The USH-9 can be integrated into a PLC system as a slave device. It supports the PROFIBUS, PROFINET, EtherCAT and CANopen protocols. This requires an additional serial converter, e.g. Anybus Communicator.

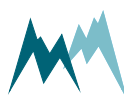

## 13 Analog output

### 13.1 What can I do with it?

Measurement values of level, distance, temperature and a status can be returned by two analog 4...20 mA signals. These analog signals can then be used to trigger a certain action, e.g. operate a switch.

### 13.2 How to wire analog outputs

Connect the analog outputs of the USH-9 to a data acquisition device according to the figure below.

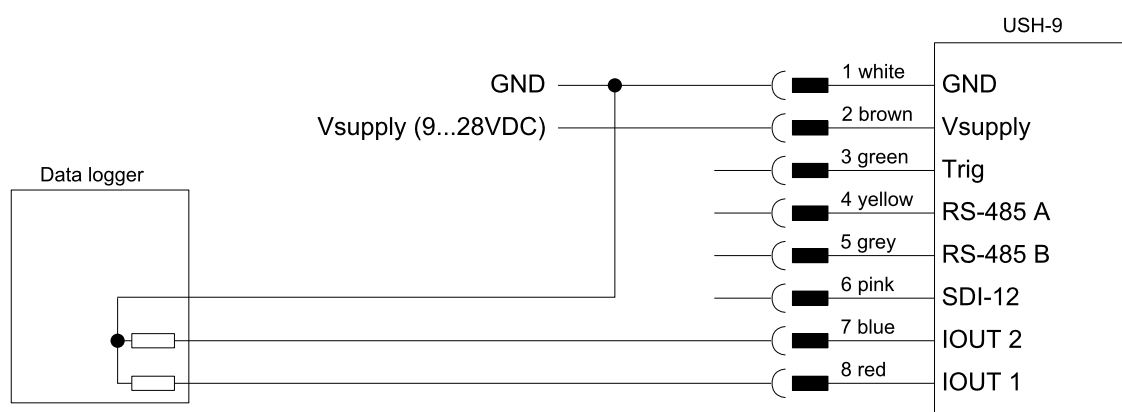

**NOTE** If a data logger is connected to the IOUT outputs, the resistance of the logger input(s) must not exceed 470  $\Omega$ .

### 13.3 Activation

In the setting [Status](#) the state of the analog output can be set to on of the following options:

ID	Option	Description
1	off (default)	Analog outputs are inactive.
2	just during TRIG	Analog outputs are only active, if an external signal is present at the TRIG input. The outputs are high as long as the signal at the TRIG input is high.
3	always on	Analog outputs are permanently active.



**NOTE** The USH-9 delays analog data acquisition by 200 ms. If **Status** is set to *just during TRIG*, the analog output must be read with a delay of min. 200 ms after the trigger has been sent. This ensures that the analog measurement has sufficiently stabilized. As the analog measurement itself requires some time, the result should be read with a delay of *measurement duration + min. 1 second*.

## 13.4 Scaling

The variables and their analog output range are configured as described below.



### NOTE

The analog outputs may return currents between 0 and 21 mA. However, the accuracies stated in the specifications are only valid for signals within 4 to 20 mA!

If the measured value falls below or exceeds the 3.9...21 mA range, 3.9 mA and 21 mA, respectively, are returned. An exception are the measurement values 99999998 and 99999997, which return a 3.8-mA and 3.7-mA signal, respectively.



**ATTENTION** The 4-mA output should correspond to a measurement value at or below the expected minimum! With low current output the accuracy tends to decrease and cross-talk with other analog channels may occur.

### 13.4.1 IOOUT 1

The measured level or distance can be returned as an analog 4...20 mA signal on pin 8 of the MAIN connector. Select level or distance in **IOOUT1, function**. The span and offset have to be selected to



cover the maximum expected level. See the illustration below for the default configuration.



**EXAMPLE**

In the default configuration the parameter **IOUT1, 4 mA value** is set to **0** and **IOUT1, 4-20 mA span** to **10'000 mm**, as illustrated below. If the USH-9 is mounted at a lower height, it is recommended to keep this setting.

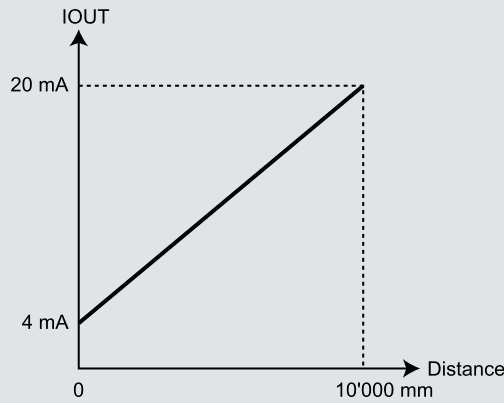

### 13.4.2 IOUT 2

The measured air temperature or a status as configured in **Status limits** in can be returned as an analog 4...20 mA signal on pin 7 of the MAIN connector.

If the air temperature is selected as output, the span is set to 100 °C and the offset to -40°C as default.

If one of the status options is selected and the conditions specified in **Status limits** are satisfied, the output is set to high (20 mA) and otherwise to low (0 mA). The following status options are available:

ID	Option	Description
1	off (default)	IOUT2 is inactive.
2	value, temperature	The air temperature is returned.
3	status, level limit	If the level exceeds the limit specified in <b>Level limit</b> , 20 mA is applied, otherwise 0 mA.

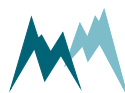

ID	Option	Description
4	status, snow settling	If the USH-9 detects a snow cover 20 mA is applied, otherwise 0 mA. A snow cover is detected if <b>Snow settling, strength drop</b> exceeds the specified limit and <b>Snow settling, maximum level</b> is not reached.
5	status, snowfall	If the USH-9 detects snowfall 20 mA is applied, otherwise 0 mA. Snowfall is detected if <b>Snowfall, precipitation limit</b> is exceeded and the temperature is below <b>Snowfall, max. temperature</b> .
6	status, all limits	If any limit mentioned above is violated, 20 mA is applied, otherwise 0 mA.

## 13.5 Simulate current output

With this function the analog outputs can be simulated. A user-defined current value between 4 and 20 mA is applied to the analog output pins, which can be read with a connected data logger or multimeter. By pressing Return/Enter again the simulation stops.

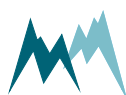

# 14 Parameter definitions

A	Measurement trigger .....	99
B	Measurement Interval .....	99
C	Level and distance .....	100
D	Technics .....	103
E	Special functions .....	120
F	Measurement table .....	121

## A Measurement trigger

`generic-measurement-trigger`

Measurements are initiated by one of the options listed in the table below.

The commands to trigger measurements via RS-485 and SDI-12 are described in [Communication](#).

Measured data are either returned directly after the measurement or can be requested by commands via the RS-485 or SDI-12 interface. The format of the returned data can be configured in the sub-menu [Output protocol \(OP\)](#).

ID	Option	Description
1	Interval (default)	Measurements are initiated in a specified interval.
2	TRIG input	Measurements are triggered by the positive edge of a DC-voltage signal applied to the TRIG input (low: 0 ... 0.6 V, high: 2.2 ... 28 V, pulse duration must be $\geq 500$ ms, delay between pulses must be $\geq 500$ ms)
3	SDI-12/RS-485	Measurements are externally triggered by commands via RS-485 or SDI-12 from ,e.g. a data logger.
4	all allowed	Measurement is triggered by all options mentioned above.

## B Measurement Interval

`generic-measurement-interval`

An internal measurement interval can be set for the USH-9. If selected in menu item [Measurement trigger](#), measurements are performed in the defined interval. However, a measurement is always completed before a new one is initiated.

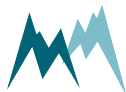

Value range	Default	Units
20...18'000	60	s

## C Level and distance

C-A	Measurement duration .....	100
C-B	Level/distance test .....	100
C-C	Adjust level .....	100
C-D	Distance to zero level .....	101
C-E	Application .....	101
C-F	Moving filter, duration .....	101
C-G	Moving filter, type .....	102

### C-A Measurement duration

`ush-measurement-duration`

The duration of a single measurement. During this time the ultrasonic signal is recorded and the distance to the monitored surface calculated. Generally, a measurement duration of 6 s is recommended.

Value range	Default	Units
2...20	6	s



**ATTENTION** A longer measurement time increases power consumption but also improves the precision of the results.

### C-B Level/distance test

`ush-level-test`

Function to test the level/distance measurement. Initiates a measurement and returns the current distance and level.

### C-C Adjust level

`ush-adjust-level`

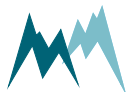

Function to adjust the level measurement of the USH-9 to the actual level. It first initiates a measurement and then requests the actual level. Adjusting the level will alter the parameter [Distance to zero level](#).

## C-D Distance to zero level

ush-distance-zero-level

The distance between the sensors lower edge and the ground surface, e.g. lowest point of river bed, ground without snow.

Value range	Default	Units
-9'999'999...99'999'999	10'000	mm

## C-E Application

ush-application

Switch to activate the settings for specific applications as listed in the following table:

ID	Option	Description
1	snow (default)	Settings for snow applications are active. These settings include precipitation detection and snowfall limits (see <a href="#">Status limits</a> and <a href="#">Advanced settings</a> ). Rate of change filtering (RoC, max. without precip. (./h) and RoC, max. at precip. (./h)) is active.
2	water	Settings for water application are active. Precipitation detection and rate of change filtering (RoC) are deactivated.
3	others	Settings for water and snow applications are inactive. Used for generic level/distance measurements. A constant rate of change filter ( <a href="#">Rate of change, maximum (./h)</a> ) is active.

## C-F Moving filter, duration

ush-moving-filter-duration

Every level/distance measurement is stored internally in a buffer for filtering. This setting defines the length of the time window of which the data are stored in the buffer. If the buffer is full, the oldest value is replaced by the most recent one.

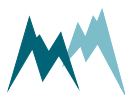

The figure below illustrates the default moving filter duration of 180 seconds. While a **Measurement Interval** of 90 seconds embraces two measurement values, an interval of 45 seconds includes 4 values.

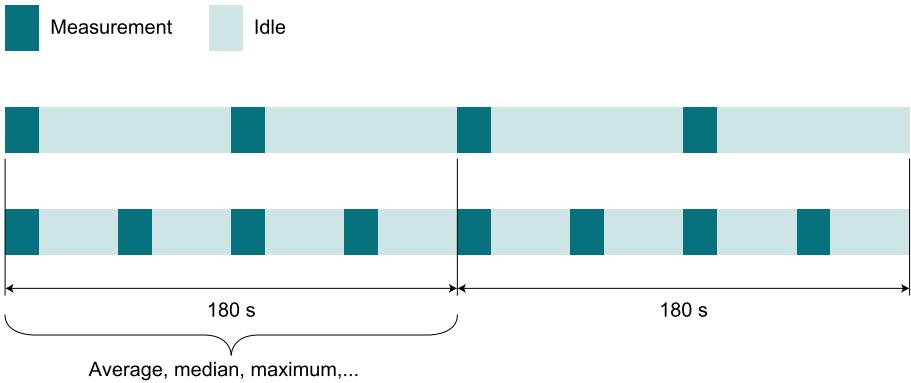

Value range	Default	Units
0...99'999'999	180	s

### C-G Moving filter, type

ush-moving-filter-type

The level/distance values in the buffer can be filtered by one of the following options:

ID	Option	Description
1	average	The mean value of all buffered values is calculated.
2	elim. neg. spikes	To eliminate negative spikes, the mean value is calculated without the 5 lowest buffered values. If the buffer size is smaller than 10, half of the values are eliminated.
3	maximum	The highest value from the buffer is returned.
4	median	The median value of the buffered data is returned.
5	elim. pos. spikes	To eliminate positive spikes, the mean value is calculated without the 5 highest buffered values. If the buffer size is smaller than 10, half of the values are eliminated.
6	elim. all spike (default)	To eliminate positive and negative spikes, the mean value is calculated without the 5 highest and 5 lowest buffered values. If the buffer size is smaller than 15, two third of the values are eliminated.

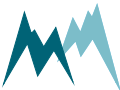

## D Technics

D-A	Language/Sprache .....	103
D-B	Decimal character .....	103
D-C	SDI-12 address .....	103
D-D	Units and decimals .....	104
D-E	Temperature .....	105
D-F	IOUT settings .....	106
D-G	Status limits .....	109
D-H	Advanced settings .....	111
D-I	RS-485 Protocol .....	114
D-J	RS-485 Port .....	117

### D-A Language/Sprache

`generic-language`

The menu language.

ID	Option	Description
1	german/deutsch	German language
2	english/englisch (default)	English language

### D-B Decimal character

`generic-decimals-character`

The character used as decimal separator in the values of the settings and in serial data strings.

ID	Option	Description
1	comma	-
2	dot (default)	-

### D-C SDI-12 address

`generic-sdi-12-address`

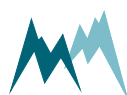

The address is a unique identifier of the sensor within a SDI-12 bus system.

Value range	Default	Units
0...9, a...z, A...Z	0	-

## D-D Units and decimals

D-D-A	Level, unit .....	104
D-D-B	Level, decimals .....	104
D-D-C	Temperature, unit .....	105
D-D-D	Temperature, decimals .....	105

### D-D-A Level, unit

`generic-units-level`

The following units of the level/distance can be selected:

ID	Option	Description
1	mm (default)	Millimeter
2	cm	Centimeter
3	m	Meter
4	in	Inch
5	ft	Feet
6	yd	Yard

### D-D-B Level, decimals

`generic-decimals-level`

The number of decimal places for the measured level/distance.

Value range	Default	Units
0...6	0	-

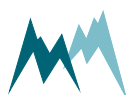



## D-D-C Temperature, unit

generic-units-temperature

The following units of the air temperature can be selected:

ID	Option	Description
1	°C (default)	Degrees Celsius
2	°F	Fahrenheit

## D-D-D Temperature, decimals

generic-decimals-temperature

The number of decimal places for the measured air temperature.

Value range	Default	Units
0...6	2	-

## D-E Temperature

D-E-A	Offset .....	105
D-E-B	Adjustment .....	105
D-E-C	Test .....	106

### D-E-A Offset

generic-temperature-offset

Offset of the USH-9 temperature sensor. An offset might be required if the sensor needs to be matched to an external reference.

Value range	Default	Units
-9'999.99...99'999.99	0	°C

### D-E-B Adjustment

generic-temperature-adjustment

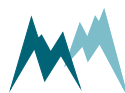

Function to adjust the measurement of the USH-9 temperature sensor. Applying this function will update the setting [Offset](#).

## D-E-C Test

`generic-temperature-test`

Function to test the USH-9 temperature sensor.

## D-F IOOUT settings

D-F-A	Status .....	106
D-F-B	IOOUT1, function .....	106
D-F-C	IOOUT1, 4-20 mA span .....	107
D-F-D	IOOUT1, 4 mA value .....	107
D-F-E	IOOUT2, function .....	107
D-F-F	IOOUT2, temperature 4-20 mA span .....	108
D-F-G	IOOUT2, temperature 4 mA value .....	108
D-F-H	IOOUT2, status hold time .....	108
D-F-I	Simulate current output .....	109

### D-F-A Status

`generic-analog-out-status`

The status defines the behavior of the analog outputs.

ID	Option	Description
1	off (default)	Analog outputs are inactive.
2	just during TRIG	Analog outputs are only active, if an external signal is present at the TRIG input. The outputs are high as long as the signal at the TRIG input is high.
3	always on	Analog outputs are permanently active.

### D-F-B IOOUT1, function

`ush-iout1-function`

Defines the variable returned by IOOUT1. The following options are available:

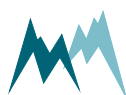

ID	Option	Description
1	distance (default)	The distance between sensor and snow surface is returned.
2	level	The level is returned (distance between ground and snow surface)

### D-F-C IOUT1, 4-20 mA span

`usb-iout1-span`

Defines the output range of the 4-20 mA signal of IOUT1. The span should cover the expected range of the level or distance, respectively.



#### EXAMPLE

Minimum level: 0 cm

Maximum expected level: 400 cm

This gives an offset of 0 cm and a level span of 400 cm. To interpret the output more easily select a span value of 480 cm; thus, a current of 1 mA corresponds to a level of 30 cm.

Value range	Default	Units
-9'999'999...99'999'999	10'000 (default)	Unit of level

### D-F-D IOUT1, 4 mA value

`ush-iout1-4ma-value`

Defines the minimum level/distance that corresponds to the 4 mA current output. For snow depth this value is usually zero.

Value range	Default	Units
-9'999'999...99'999'999	0	Unit of level

### D-F-E IOUT2, function

`ush-iout2-function`

Defines the variable returned by IOUT2. The following options are available:

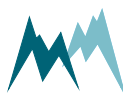

ID	Option	Description
1	off (default)	IOUT2 is inactive.
2	value, temperature	The air temperature is returned.
3	status, level limit	If the level exceeds the limit specified in <a href="#">Level limit</a> , 20 mA is applied, otherwise 0 mA.
4	status, snow settling	If the USH-9 detects a snow cover 20 mA is applied, otherwise 0 mA. A snow cover is detected if <a href="#">Snow settling, strength drop</a> exceeds the specified limit and <a href="#">Snow settling, maximum level</a> is not reached.
5	status, snowfall	If the USH-9 detects snowfall 20 mA is applied, otherwise 0 mA. Snowfall is detected if <a href="#">Snowfall, precipitation limit</a> is exceeded and the temperature is below <a href="#">Snowfall, max. temperature</a> .
6	status, all limits	If any limit mentioned above is violated, 20 mA is applied, otherwise 0 mA.

**D-F-F IOUT2, temperature 4-20 mA span**

```
ush-iout2-temperature-span
```

Defines the output range of the 4-20 mA signal of IOUT2 . The span should cover the air temperature range expected at the measurement site.

Value range	Default	Units
-9'999'999...99'999'999	100	Unit of temperature

**D-F-G IOUT2, temperature 4 mA value**

```
ush-iout2-temperature-4ma-value
```

Defines the minimum air temperature that corresponds to the 4 mA current output.

Value range	Default	Units
-9'999'999...99'999'999	-40	Unit of temperature

**D-F-H IOUT2, status hold time**

```
ush-iout2-status-hold-time
```

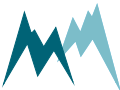

If a limit defined in [Status limits](#) is reached, the status of IOUT2 is set to high and 20 mA is applied to the output. This status is maintained until the specified hold time elapses. Setting this parameter suppresses a flickering signal if the monitored variable fluctuates around the limit value.

Value range	Default	Units
0...360	30 (default)	min

## D-F-I Simulate current output

`generic-analog-out-simulate-current`

With this function the analog outputs can be simulated. Upon submission of a current value between 4 and 20 mA the corresponding values of the selected variable are displayed. The selected current is also applied to the analog outputs and can be read with a connected data logger or multimeter. By pressing Return/Enter again the simulation stops.



### NOTE

If [Status](#) is deactivated, no current output can be simulated.

If [Status](#) is set to [just during TRIG](#), the trigger must be set prior to simulation. Additionally, the trigger must be reset before each simulation.

## D-G Status limits

D-G-A	Level limit .....	109
D-G-B	Snow settling, strength drop .....	110
D-G-C	Snow settling, maximum level .....	110
D-G-D	Snowfall, precipitation limit .....	110
D-G-E	Snowfall, max. temperature .....	110

### D-G-A Level limit

`ush-level-limit`

The level above which the status is set to high. This limit is used to report significant levels or snow depths.

Value range	Default	Units
0...99'999'999	0	mm

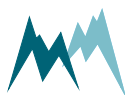

## D-G-B Snow settling, strength drop

ush-snow-settling-strength

Only available if **Application** is set to *snow*. Generally used to detect snow settling, e.g. for monitoring of road conditions. If the signal strength drops by the specified value, snow starts to build up on a previously snow-free surface.

Value range	Default	Units
0...50	0	dB

## D-G-C Snow settling, maximum level

ush-snow-settling-max-level

Only available if **Application** is set to *snow*. Generally used to detect snow settling, e.g. for monitoring of road conditions.

When snow starts to accumulate on a previously snow-free surface, and **Snow settling, strength drop** falls below its limit, the status “snow settling” is set to high. Once the maximum level is reached, the status is set to low again.

Value range	Default	Units
0...99'999'999	50	mm

## D-G-D Snowfall, precipitation limit

ush-snowfall-precip-limit

Only available if **Application** is set to *snow*; used to report snowfall. The USH-9 returns precipitation as dimensionless value that represents both, precipitation type and intensity. To identify precipitation as snow and to trigger the status “snowfall”, the value must exceed the specified limit, and the air temperature must be lower than **Snowfall, max. temperature..**

Value range	Default	Units
0...1'000	0	-

## D-G-E Snowfall, max. temperature

ush-snowfall-max-temperature

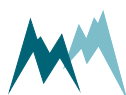

Only available if **Application** is set to *snow*; used to report snowfall. The air temperature below which precipitation is expected to fall as snow.

Value range	Default	Units
-99'999.99...99'999.99	2.0	Unit of temperature

## D-H Advanced settings

D-H-A	Optimisation .....	111
D-H-B	Max. measurement distance .....	111
D-H-C	View spectral distribution .....	112
D-H-D	Maximum standard deviation .....	112
D-H-E	Rate of change, maximum (./h) .....	112
D-H-F	RoC, max. without precip. (./h) .....	112
D-H-G	RoC, max. at precip. (./h) .....	113
D-H-H	Precipitation, filter duration .....	113
D-H-I	Reset behavior .....	113
D-H-J	Sleep mode .....	114
D-H-K	Sommer ID .....	114

### D-H-A Optimisation

`ush-optimisation`

Only available if **Application** is set to *water* or *others*. Adapts the settings of the level/distance analysis to the conditions of the sensors environment.

ID	Option	Description
1	indoor (default)	The USH-9 does not apply confirmation shots to determine the level/distance.
2	outdoor	The USH-9 applies confirmation shots to determine the level/distance.

### D-H-B Max. measurement distance

`ush-max-measurement-distance`

Maximum expected distance between the sensor and the target surface. A shorter distance increases precision. This may be required if the zero level (specified in **Distance to zero level**) has a datum that is outside the measurement range. The minimum value is 1000 mm.

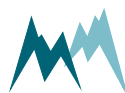

Value range	Default	Units
1'000...99'999'999	10'000	mm

### D-H-C View spectral distribution

`generic-special-functions-view-spectral-distribution`

With this command the sensor is set into spectral mode. After 30 minutes the spectral mode is switched off automatically.

With the Commander software the spectra can be recorded, visualized and stored for expert analysis of the sensor signal, e.g. additional reflections.

### D-H-D Maximum standard deviation

`ush-max-standard-deviation`

At the beginning of each measurement the USH-9 fires an impulse to detect the approximate position of the snow surface. Subsequent impulses then determine the exact snow depth. This setting specifies the maximum acceptable standard deviation of a complete measurement.

Value range	Default	Units
0...99'999'999	70	mm

### D-H-E Rate of change, maximum (./h)

`ush-roc-max`

Only applicable if [Application](#) is set to *others*. Maximum permissible rate at which the level is allowed to change.

Value range	Default	Units
0...99'999'999	30	mm/h

### D-H-F RoC, max. without precip. (./h)

`ush-roc-max-without-precip`

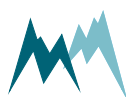



Only applicable if **Application** is set to *snow*. Maximum permissible rate at which the level is allowed to change when there is no snowfall.

Value range	Default	Units
0...99'999'999	300	mm/h

### D-H-G RoC, max. at precip. (./h)

`ush-roc-max-precip`

Only applicable if **Application** is set to *snow*. Maximum permissible rate at which the level is allowed to change during snowfall.

Value range	Default	Units
0...99'999'999	300	mm/h



**NOTE** The USH-9 does not detect drifting snow, and **RoC, max. at precip. (./h)** is not active in such conditions! At monitoring sites with frequent drifting snow consider to increase **RoC, max. without precip. (./h)**.

### D-H-H Precipitation, filter duration

`ush-precipitation-filter-duration`

Only available if **Application** is active. As the signal reflected by precipitation is very noisy, the USH-9 filters the precipitation value by a moving average with the specified filter duration.

Value range	Default	Units
0...99'999'999	360	s

### D-H-I Reset behavior

`generic-reset-behavior`

The USH-9 keeps certain sensor data in its memory, e.g. the measured data for calculation of the moving average. This setting defines whether the acquired sensor data are deleted upon a sensor reset or not.

ID	Option	Description
1	hard reset	A reset deletes all acquired and stored sensor data.
2	soft reset (default)	All acquired and stored sensor data are kept for measurements and calculations.

 **NOTE** During the installation a hard reset is recommended. After finishing the installation a soft reset should be selected. This shortens start-up time.

### D-H-J Sleep mode

`generic-sleep-mode`

Defines the behavior of the USH-9 between two measurements, provided the measurement interval is longer than the time of the measurement itself. The following options are available:

ID	Option	Description
1	MODBUS, fast	For MODBUS applications. The USH-9 stays in normal mode. This option permits high data transmission rates, but increases power consumption.
2	MODBUS, slow	For MODBUS applications. The USH-9 goes into idle mode and can be woken up by a command via the RS-485 interface with a low baud rate. This option reduces power consumption at lower data transmission rates.
3	Standard (default)	The USH-9 goes into sleep mode and can be woken up by a command via the RS-485 interface only with a time delay. Option with the lowest power consumption.

### D-H-K Sommer ID

`generic-sommer-id`

The Sommer ID is used to define stations within the Commander software. The ID is preset in the device and corresponds to its serial number. SOMMER suggests not to change the ID, except if a USH-9 device is replaced. In such a case it can be practical to change the ID of the new device to the ID of the replaced device to guarantee data consistency.

### D-I RS-485 Protocol

D-I-A Device number ..... 115

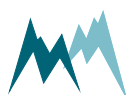

D-I-B	System key .....	115
D-I-C	Output protocol (OP) .....	115
D-I-D	OP, measurement output .....	116
D-I-E	OP, information .....	116
D-I-F	OP, wake-up sequence .....	116
D-I-G	OP, prefix holdback .....	117
D-I-H	MODBUS, set default .....	117
D-I-I	MODBUS, device address .....	117

## D-I-A Device number

`generic-rs-485-protocol-device-number`

The device number is used for the unique identification of the device in a bus system.

Value range	Default	Units
0...98	0 (default)	-

## D-I-B System key

`generic-rs-485-protocol-system-key`

The system key defines the bus system of the device. Thus, different conceptual bus systems can be separated. Interfering bus systems occur if the remote radio coverage of two measurement systems overlap. In general, the system key should be set to 00.

Value range	Default	Units
0...99	0	-

## D-I-C Output protocol (OP)

`generic-rs-485-protocol-output-protocol`

The type of the serial output protocol. The following options are available:

ID	Option	Description
1	Sommer (default)	Sommer protocol; data values are returned with an index starting at 1
2	Standard	Standard protocol; data values are returned without an index
3	MODBUS	Modbus protocol

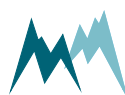



**NOTE** For MODBUS applications run `MODBUS, set default` to get the appropriate communication settings.

## D-I-D OP, measurement output

`generic-rs-485-protocol-measurement-output`

Specifies the timing of the serial data output.

ID	Option	Description
1	just per command	The output is only requested by commands via the RS-485 or SDI-12 interface.
2	after measurement (default)	The serial data output is performed automatically right after each measurement.
3	pos. TRIG slope	The output is triggered by a positive edge of a control signal applied to the trigger input.

## D-I-E OP, information

`generic-rs-485-protocol-information`

The main measurement values are always included in the data output string. Additionally, special and analysis values can be included.

ID	Option	Description
1	main values	Only the main values are returned.
2	& special values (default)	Main values and special values are returned.
3	& analysis values	Main, special and analysis values are returned.

## D-I-F OP, wake-up sequence

`generic-rs-485-protocol-wake-up-sequence`

Serial data can be transmitted to a recording device automatically without a request. However, many devices demand a wake-up sequence before they can receive and process data. The USH-9 has the option to send a sync sequence and a prefix before data are transmitted (see [Waking-up a connected data logger](#)). The following options are available:

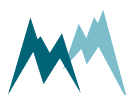

ID	Option	Description
1	off	No wake-up sequence
2	sync	The sync sequence UU~?~? is sent before the output string.
3	prefix (default)	A blank with a time delay is sent before the output string.
4	prefix & sync	A blank with a time delay and the sync sequence UU~?~? is sent before the output string.

### D-I-G OP, prefix holdback

`generic-rs-485-protocol-prefix-holdback`

The hold-back time defines the time delay between the prefix and the data string.

Value range	Default	Units
0...5'000	300	ms

### D-I-H MODBUS, set default

`generic-rs-485-protocol-modbus-set-default`

Only available in terminal mode. The Modbus protocol demands a defined setting, including multiple parameters. This command sets all these parameters automatically (see [Modbus](#)).

### D-I-I MODBUS, device address

`generic-rs-485-protocol-modbus-device-address`

Unique device address for the Modbus protocol.

Value range	Default	Units
1...247	35	-

## D-J RS-485 Port

D-J-A Baud rate ..... 118

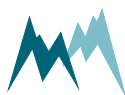

D-J-B	Parity, stop bits .....	118
D-J-C	Minimum response time .....	119
D-J-D	Transmitter warm-up time .....	119
D-J-E	Flow control .....	119
D-J-F	Sending window .....	119
D-J-G	Receiving window .....	120

## D-J-A Baud rate

`generic-rs-485-port-baud-rate`

The following transmission rates in bps (baud) can be selected:

ID	Option	Description
1	1'200	-
2	2'400	-
3	4'800	-
4	9'600 (default)	-
5	19'200	-
6	38'400	-
7	57'600	-
8	115'200	-

## D-J-B Parity, stop bits

`generic-rs-485-port-parity-stop-bits`

The following combinations of parity and stop bits can be selected:

ID	Option	Description
1	no par, 1 stop (default)	No parity and 1 stop bit
2	no par, 2 stop	No parity and 2 stop bits
3	even par, 1 stop	Even parity and 1 stop bit
4	odd par, 1 stop	Odd parity and 1 stop bit

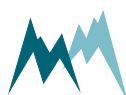

## D-J-C Minimum response time

`generic-rs-485-port-minimum-response-time`

Setting of this parameter avoids interference of communication at the RS-485 interface. For this purpose the response to a command is delayed by the selected time. Additionally, the response is kept compact.

Value range	Default	Units
0...2'000	10	ms

## D-J-D Transmitter warm-up time

`generic-rs-485-port-transmitter-warm-up-time`

The transmitter warm-up time defines the time before data is sent.

Value range	Default	Units
0...2'000	10	ms

## D-J-E Flow control

`generic-rs-485-port-flow-control`

The XOFF-XON flow control can be activated with this setting.

ID	Option	Description
1	Off (default)	no flow control
2	XOFF-XON blocking	XOFF-XON flow control, especially adapted for half-duplex systems



**ATTENTION** To use spectrum mode ([View spectral distribution](#)) set **Flow control** to *XOFF-XON blocking*. This enables a return to normal mode at any time.

## D-J-F Sending window

`generic-rs-485-port-sending-window`

If XON-XOFF flow control is activated data are transmitted in blocks with the defined length.

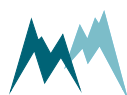

Value range	Default	Units
200...5'000	300	ms

## D-J-G Receiving window

`generic-rs-485-port-receiving-window`

If XON-XOFF flow control is activated transmission of blocks is delayed by the specified time.

Value range	Default	Units
200...5'000	300	ms

## E Special functions

E-A	Device status .....	120
E-B	View setup .....	120
E-C	Continuous meas. mode (temp). .....	120
E-D	Set factory default .....	121
E-E	Temp. load factory default .....	121
E-F	Relaunch program .....	121

### E-A Device status

`generic-special-functions-device-status`

Displays information about the sensor and the software version.

### E-B View setup

`generic-special-functions-view-setup`

All parameters of the USH-9 are listed in the terminal window.

### E-C Continuous meas. mode (temp).

`generic-special-functions-continuous-meas-mode`

Inactive in the Commander menu. This feature can be triggered under the **Measurement (F3)** tab with the command **Start polling measurements**. When active, measurements are performed continuously, ignoring the specified measurement interval.

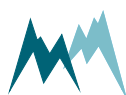



## E-D Set factory default

`generic-special-functions-set-factory-default`

All parameters are reset to factory defaults. Only available in terminal-mode.

## E-E Temp. load factory default

`generic-special-functions-temp-load-factory-default`

Loads factory default values temporarily. Only available in terminal mode.

## E-F Relaunch program

`generic-special-functions-relaunch-program`

The device is restarted. Powering the sensor off and on again is equivalent.

## F Measurement table

`generic-measurement-table`

Lists all measured variables with their units (see [Communication](#)).

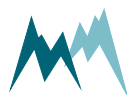

## Appendix A Device Errors

By configuring the USH-9 to return analysis values any error of the device can be recorded (see also [Data output](#)).

The error code is displayed as a decimal number of which the value left of the decimal point refers to fatal errors and the value right of the decimal point to minor errors. By converting these two numbers to their hex-values the errors as listed in the following tables can be identified.



**NOTE** If multiple errors occur, they are added and the summed error code is returned. The error code can be reset with the function [Device status](#).

Error code	Name	Description
0x00000004	SYSTEM_MAIN_BAD_VSCHUSS_ERROR	Supply voltage is out of bounds.
0x00000008	SYSTEM_MAIN_A6V0TO_LOW_ERROR	6V power supply for analog outputs and RS-485 interface is out of bounds.
0x00000010	SYSTEM_PRIMADC_NOXREF_ERROR	Power supply of AD-converter that reads the Pt1000 output is out of bounds.
0x00000020	SYSTEM_PRIMADC_BAD_SW_ERROR	Obsolete
0x00000040	SYSTEM_PRIMADC_AD7798_ERROR	Error-bit of AD-converter is set.
0x00000080	SYSTEM_PRIMADC_TIMEOUT_ERROR	AD-converter receives no results.
0x00000100	SYSTEM_PRIMADC_NOTCALIB_ERROR	Pt1000 is not or badly calibrated.
0x00000200	SYSTEM_PRIMADC_OUT_OF_BOUNDS_ERROR	Current across Pt1000 and shunt resistor is too low.
0x00000400	SYSTEM_SCAN_ERROR	Measurement has been canceled.
0x00000800	SYSTEM_SCAN_BLOCKED_NEARFIELD	The target surface or another object is within the near field of the USH-9. Subsequent measurement may be invalid!
0x00001000	SYSTEM_SCAN_MIXEDMIRRORCONDITITIONS	May only occur during indoor-use. Subsequent ultrasonic shots have identified different peaks. USH-9 returns <i>Hold</i> value.

Table 1 Fatal device errors



Error code	Name	Description
0x01	SYSTEM_MAIN_AVEXT_ERROR	Voltage of external power supply is not measured correctly.
0x02	SYSTEM_MAIN_A6V0_ERROR	Voltage of 6V power supply is too high.
0x04	SYSTEM_MAIN_TEMP_ERROR	Internal temperature sensor returns invalid data.
0x08	SYSTEM_NO_TARGET_CLEARANCE	May only occur during outdoor-use. Spread of distance acquired by confirmation-shots is too large.
0x10	SYSTEM_DIFFERENT_MIRRORING	May only occur during indoor-use. If three ultrasonic shots have been fired, and shots one and three returned the same result instead of shots one and two.
0x40	SYSTEM_MAIN_REBOOT_ERROR	Repeated re-boot due to insufficient power supply or manual restarts.

Table 2 Minor device errors



## Appendix B Troubleshooting

B.1	Devices .....	124
B.1.1	The USH-9 is not responding .....	124
B.1.2	The USH-9 reboots repeatedly .....	126
B.2	Measurement data .....	126
B.2.1	Measurement data are not updated .....	126
B.2.2	Snow height increase is retarded .....	126
B.2.3	Recorded data show frequent data gaps .....	127
B.3	Firmware & software .....	127
B.3.1	Commander loads wrong setup .....	127
B.3.2	Firmware update via RS-485 is aborted .....	127
B.4	SDI-12 .....	128
B.4.1	Data logger receives no SDI-12 data .....	128
B.4.2	The USH-9 is not detected by a SDI-12 master device .....	128
B.5	Analog output .....	129
B.5.1	The 4-20 mA output is wrong .....	129

### B.1 Devices

#### B.1.1 The USH-9 is not responding

Reason	Solution
The power supply is not connected or turned off.	Check if the power supply is connected and on.
The polarity of connected power supply wires is wrong.	Check the polarity of connected wires.
Wrong sensor cable.	Use the original sensor cable configured by Sommer Messtechnik (only applicable to Sommer Messtechnik cables).

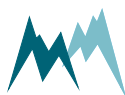

Reason	Solution
Power supply is insufficient. The USH-9 requires a certain inrush-current that the power supply is not able to provide.	<ol style="list-style-type: none"> <li>1. Use a power supply providing &gt;0.5 A at 12 VDC or a fully charged battery.</li> <li>2. In case of long sensor cables (&gt;50 m) use a 24-VDC power supply.</li> </ol> <p> <b>NOTE</b> Please note that power supplied by the USB-port is insufficient to power the USH-9!</p>
The power supply voltage is out of range.	Adjust the power supply to match the specified voltage range.
The port settings of the USH-9 and the data acquisition system do not match.	<p>Use the Commander <b>Communication assistant</b> or adapt port settings on your device.</p> <p> <b>NOTE</b> Sommer Messtechnik devices require the following Baud rates:</p> <ul style="list-style-type: none"> <li>● Sensor: 9600</li> <li>● Data logger: 115200</li> <li>● Modbus: 19200</li> </ul> <p>In case of doubt use the function <b>Check port</b> in the <b>Communication assistant</b>.</p>
The COM-port has not assigned correctly to the USB converter.	<ol style="list-style-type: none"> <li>1. Make sure to use a Sommer Messtechnik USB converter. Third party converters are not supported.</li> <li>2. Check the COM-port number using <b>Windows Device Manager</b>.</li> <li>3. Plug in the USB converter first, then start Commander.</li> </ol>
A sensor wire is not connected firmly to the terminal of the data acquisition device.	Check the firm connection of the sensor wires.
A pin of the connector plug is bent or broken.	Verify that all connector pins are straight.

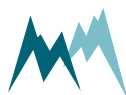

## B.1.2 The USH-9 reboots repeatedly

Reason	Solution
The power supply has not enough current to start the USH-9.	Verify that the power supply provides enough current. A USH-9 consumes up to 140 mA @ 12 V. If required, power the USH-9 by an additional or alternative supply.

## B.2 Measurement data

### B.2.1 Measurement data are not updated

The device is connected to the Commander, but the data are not updated.

Cause	Solution
Data traffic conflict	Reboot the device by interrupting the power supply.

### B.2.2 Snow height increase is retarded

Reason	Solution
Drifting snow has resulted in a fast change of the snow height.	Increase <b>RoC, max. without precip. (./h)</b> to approx. 40 mm/h.
The USH-9 does not recognize precipitation properly: <ul style="list-style-type: none"> <li>• The distance between the sensor and the snow surface is &lt; 2 m.</li> <li>• Snow drift close to the surface is not recognized as precipitation.</li> </ul>	Increase <b>RoC, max. without precip. (./h)</b> .



#### NOTE

In snow applications a rate of change (RoC) filter is active! To test the USH-9 use the function **Level/distance test** or set **Application** to **Water**.

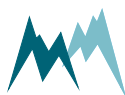

### B.2.3 Recorded data show frequent data gaps

Reason	Solution
Measured level is out of range.	Verify that level measurements are within the range of the USH-9.
USH-9 is not perpendicular to the ground	Verify that the USH-9 is mounted perpendicular to the ground (see also <a href="#">Mounting</a> ).

## B.3 Firmware & software

### B.3.1 Commander loads wrong setup

If the setup is reloaded from the device the Commander seems to display an old version.

Cause	Solution
The device has been connected to the same PC before and several different setup files have been loaded.	Delete the setup files of the device that have been downloaded by Commander to the folder <code>C:\Users\Public\Documents\Sommer\Setup</code> . The respective files can be identified by the serial number in the file name and the file date.

### B.3.2 Firmware update via RS-485 is aborted

Reason	Solution
USB to RS-485 converter cable is damaged or can only operate on 9600 baud.	Replace USB to RS-485 converter cable. The programmer requires 57600 baud.

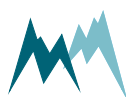

## B.4 SDI-12

### B.4.1 Data logger receives no SDI-12 data

Reason	Solution
The sensor is set to <b>Measurement trigger interval</b> , but the data logger sends a <b>M!</b> command, i.e. the data logger polls data.	If data are polled from the sensor, <b>Measurement interval</b> must be set to <b>SDI-12/RS485</b> .
The sensor is set to <b>Measurement trigger SDI-12/RS485</b> , but the data logger sends an <b>R!</b> command, i.e. the sensor pushes data.	If the sensor pushes data, <b>Measurement interval</b> must be set to <b>interval</b> .
Multiple sensors are connected to the data logger and two or more sensors have the same SDI-12 address.	If multiple sensors are connected to the same data logger, each sensor must be assigned a unique SDI-12 address.
Some third-party sensors may not issue a service request when they have completed a measurement.	If a sensor does not issue a service request after a measurement, a <b>C!</b> command instead of a <b>M!</b> command must be sent to start a measurement. Otherwise the data logger runs into a timeout or is waiting indefinitely for a service request.

### B.4.2 The USH-9 is not detected by a SDI-12 master device

Reason	Solution
The USH-9 and the SDI-12 master have different grounds.	Verify that the USH-9 and the SDI-12 master are connected by a ground (GND) wire.

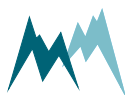



## B.5 Analog output

### B.5.1 The 4-20 mA output is wrong

Reason	Solution
Analog output settings incorrect.	<ol style="list-style-type: none"><li>1. Check analog output settings.</li><li>2. Run <b>Simulate current output</b> and verify the correct output.</li></ol>
Sensor and data acquisition system have different grounds.	Verify that sensor and data acquisition system have the same ground.
The 4-20 mA output is delayed by approx. 150 ms. If the output is read before, a wrong value is acquired.	Sample the 4-20 mA output with a delay of more than 150 ms.

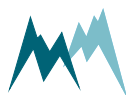

## Appendix C CRC-16 array

### CRC-16 array

```
1  crc16tab[] =
2  {
3  0x0000, 0x1021, 0x2042, 0x3063, 0x4084, 0x50A5, 0x60C6, 0x70E7,
4  0x8108, 0x9129, 0xA14A, 0xB16B, 0xC18C, 0xD1AD, 0xE1CE, 0xF1EF,
5  0x1231, 0x0210, 0x3273, 0x2252, 0x52B5, 0x4294, 0x72F7, 0x62D6,
6  0x9339, 0x8318, 0xB37B, 0xA35A, 0xD3BD, 0xC39C, 0xF3FF, 0xE3DE,
7  0x2462, 0x3443, 0x0420, 0x1401, 0x64E6, 0x74C7, 0x44A4, 0x5485,
8  0xA56A, 0xB54B, 0x8528, 0x9509, 0xE5EE, 0xF5CF, 0xC5AC, 0xD58D,
9  0x3653, 0x2672, 0x1611, 0x0630, 0x76D7, 0x66F6, 0x5695, 0x46B4,
10 0xB75B, 0xA77A, 0x9719, 0x8738, 0xF7DF, 0xE7FE, 0xD79D, 0xC7BC,
11 0x48C4, 0x58E5, 0x6886, 0x78A7, 0x0840, 0x1861, 0x2802, 0x3823,
12 0xC9CC, 0xD9ED, 0xE98E, 0xF9AF, 0x8948, 0x9969, 0xA90A, 0xB92B,
13 0x5AF5, 0x4AD4, 0x7AB7, 0x6A96, 0x1A71, 0x0A50, 0x3A33, 0x2A12,
14 0xDBFD, 0xCBDC, 0xFBBF, 0xEB9E, 0x9B79, 0x8B58, 0xBB3B, 0xAB1A,
15 0x6CA6, 0x7C87, 0x4CE4, 0x5CC5, 0x2C22, 0x3C03, 0x0C60, 0x1C41,
16 0xEDAE, 0xFD8F, 0xCDEC, 0xDDCD, 0xAD2A, 0xBD0B, 0x8D68, 0x9D49,
17 0x7E97, 0x6EB6, 0x5ED5, 0x4EF4, 0x3E13, 0x2E32, 0x1E51, 0x0E70,
18 0xFF9F, 0xEFBE, 0xDFDD, 0xCFFC, 0xBF1B, 0xAF3A, 0x9F59, 0x8F78,
19 0x9188, 0x81A9, 0xB1CA, 0xA1EB, 0xD10C, 0xC12D, 0xF14E, 0xE16F,
20 0x1080, 0x00A1, 0x30C2, 0x20E3, 0x5004, 0x4025, 0x7046, 0x6067,
21 0x83B9, 0x9398, 0xA3FB, 0xB3DA, 0xC33D, 0xD31C, 0xE37F, 0xF35E,
22 0x02B1, 0x1290, 0x22F3, 0x32D2, 0x4235, 0x5214, 0x6277, 0x7256,
23 0xB5EA, 0xA5CB, 0x95A8, 0x8589, 0xF56E, 0xE54F, 0xD52C, 0xC50D,
24 0x34E2, 0x24C3, 0x14A0, 0x0481, 0x7466, 0x6447, 0x5424, 0x4405,
25 0xA7DB, 0xB7FA, 0x8799, 0x97B8, 0xE75F, 0xF77E, 0xC71D, 0xD73C,
26 0x26D3, 0x36F2, 0x0691, 0x16B0, 0x6657, 0x7676, 0x4615, 0x5634,
27 0xD94C, 0xC96D, 0xF90E, 0xE92F, 0x99C8, 0x89E9, 0xB98A, 0xA9AB,
28 0x5844, 0x4865, 0x7806, 0x6827, 0x18C0, 0x08E1, 0x3882, 0x28A3,
29 0xCB7D, 0xDB5C, 0xEB3F, 0xFB1E, 0x8BF9, 0x9BD8, 0xABBB, 0xBB9A,
30 0x4A75, 0x5A54, 0x6A37, 0x7A16, 0x0AF1, 0x1AD0, 0x2AB3, 0x3A92,
31 0xFD2E, 0xED0F, 0xDD6C, 0xCD4D, 0xBDAA, 0xAD8B, 0x9DE8, 0x8DC9,
32 0x7C26, 0x6C07, 0x5C64, 0x4C45, 0x3CA2, 0x2C83, 0x1CE0, 0x0CC1,
33 0xEF1F, 0xFF3E, 0xCF5D, 0xDF7C, 0xAF9B, 0xBFBA, 0x8FD9, 0x9FF8,
34 0x6E17, 0x7E36, 0x4E55, 0x5E74, 0x2E93, 0x3EB2, 0x0ED1, 0x1EF0
35 }
```



# Glossary

## M

### **Modbus**

A serial communications protocol for connecting industrial electronic devices.

## R

### **RS-485**

A standard defining the signal transmission in serial communication systems.

## S

### **SDI-12**

Asynchronous serial communications protocol for intelligent sensors (Serial Digital Interface at 1200 baud)

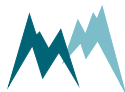

# Index

## M

Modbus 17, 53-54, 79-80, 86-88, 115, 117,  
125

## R

RS-485 12-13, 16-17, 21-22, 26, 35, 51, 53,  
62-64, 71, 74, 80, 88, 99, 114, 116-  
117, 119, 122, 127

## S

SDI-12 16-17, 21, 23, 53, 63, 74-78, 82, 99,  
103, 116, 128

